



# SERVICE PARTS LIST

**BULLETIN NO.**  
**54-24-2800**

SPECIFY CATALOG NO. AND SERIAL NO. WHEN ORDERING PARTS		REVISED BULLETIN	DATE
<b>28 VOLT 1/2" HAMMER-DRILL</b>			Aug. 2014
CATALOG NO. <b>0726-20</b>	STARTING SERIAL NO. <b>C26A</b>	WIRING INSTRUCTION <b>SEE PAGE 3</b>	

#77 Two styles of Brush Card Assemblies  
See page two

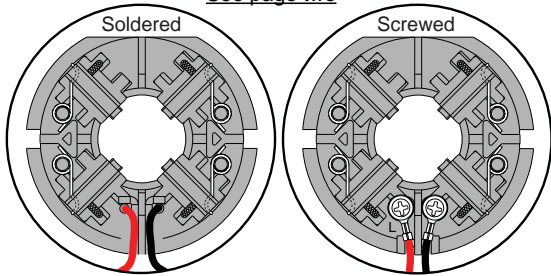

**EXAMPLE:**  
Component Parts (Small #) Are Included  
When Ordering The Assembly (Large #).

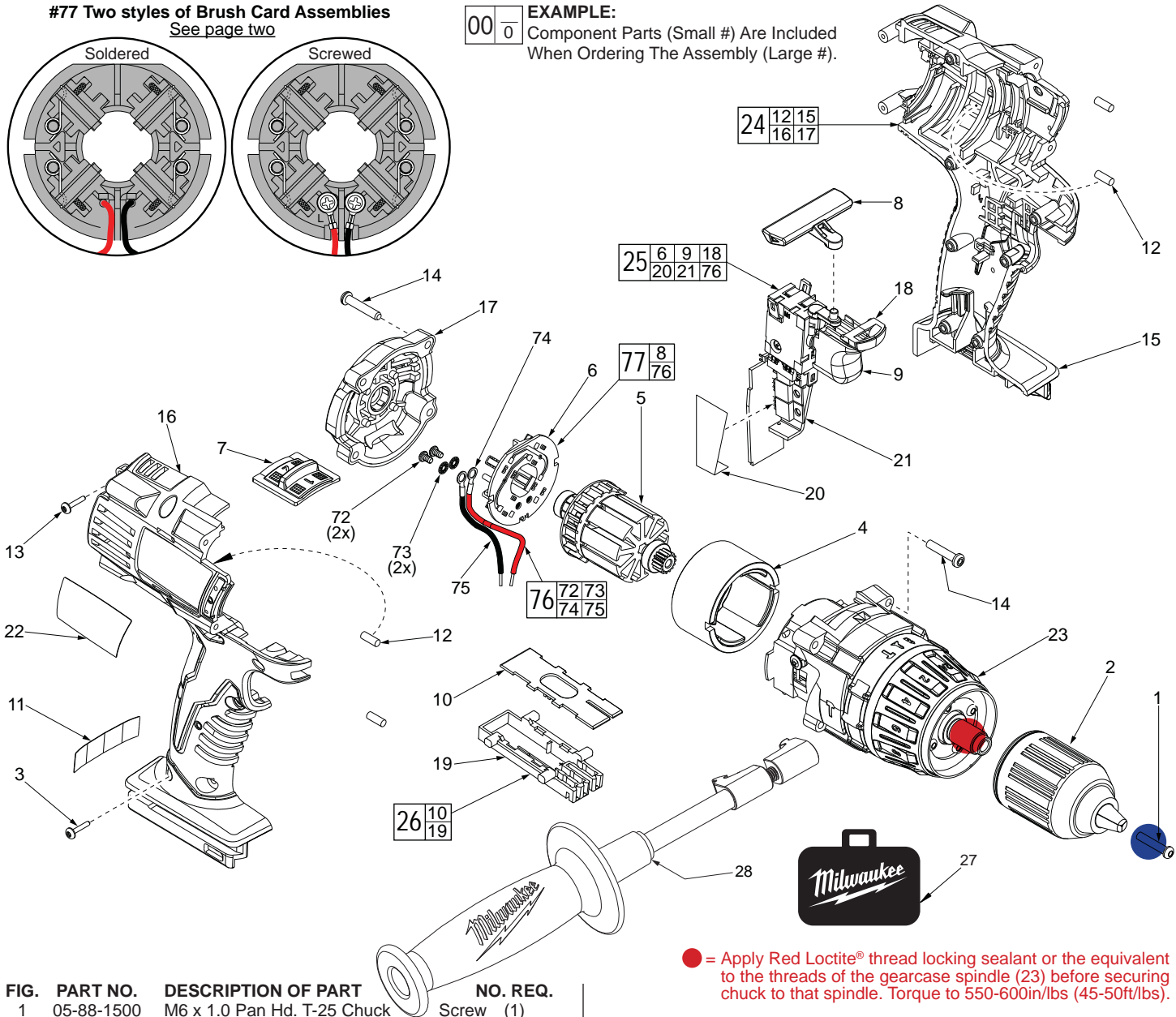
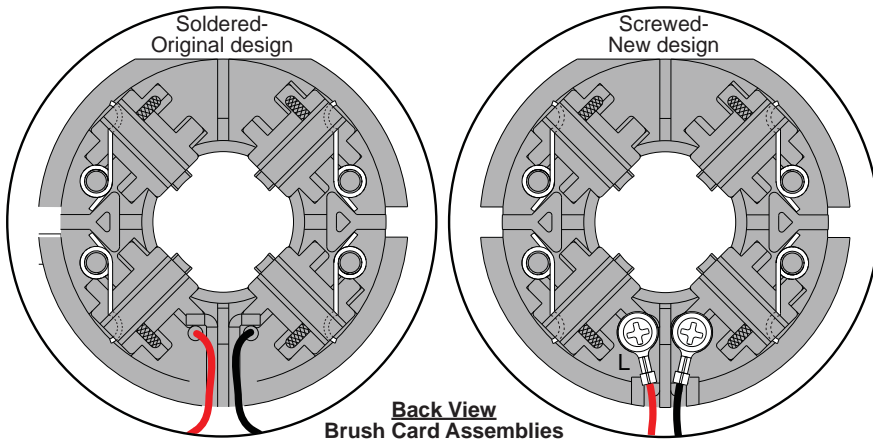

FIG.	PART NO.	DESCRIPTION OF PART	NO. REQ.
1	05-88-1500	M6 x 1.0 Pan Hd. T-25 Chuck Screw	(1)
2	42-66-0755	1/2" Keyless Chuck	(1)
3	06-82-2025	M3.5 Handle Screw T-10	(7)
4	18-01-3025	Service Field	(1)
5	16-01-3061	Service Armature Assembly	(1)
6	-----	Brush Card	(1)
7	45-24-0675	High / Low Shifter	(1)
8	42-42-0800	Forward / Reverse Button	(1)
9	-----	Switch	(1)
10	-----	Terminal Block Cover	(1)
11	10-20-2760	Warning Label	(1)
12	45-30-0255	Rubber Slug	(4)
13	06-82-6350	M3 x 16mm Handle Screw T-10	(2)
14	05-88-1710	M3.5 x 22mm End Cap/Gearcase Scr T-10	(8)
15	-----	Left Handle	(1)
16	-----	Right Handle	(1)
17	42-52-0390	End Cap	(1)
18	-----	LED Assembly	(1)
19	-----	Terminal Block	(1)
20	-----	Paper Insulator	(1)
21	-----	PCB Assembly	(1)
22	12-20-2811	Service Nameplate Kit	(1)
23	14-29-0400	Service Gearcase Assembly	(1)

**● = Apply Red Loctite® thread locking sealant or the equivalent to the threads of the gearcase spindle (23) before securing chuck to that spindle. Torque to 550-600in/lbs (45-50ft/lbs).**

**● = Apply Blue Loctite® thread locking sealant or the equivalent to the threads of the chuck screw (1) before securing chuck to the gearcase spindle. Torque to 90-100in/lbs**

FIG.	PART NO.	DESCRIPTION OF PART	NO. REQ.
24	31-44-2480	Service Housing Kit	(1)
25	23-66-1335	Switch / Brush Card Assembly	(1)
26	22-56-1185	Terminal Block Assembly	(1)
27	42-55-1050	Carrying Case	(1)
28	42-62-0526	Side Handle Assembly	(1)
72	05-88-0928	M3 x 5mm Pan Hd. T10 Screw	(2)
73	45-88-1980	Spring Washer	(2)
74	-----	Leadwire Assembly - Red	(1)
75	-----	Leadwire Assembly - Black	(1)
76	14-46-2395	Leadwire/Screw/Washer Kit	(1)
77	14-46-2018	Brush Card Assembly	(1)



**NOTE:**  
There are two Brush Card Assembly designs.

On the original brush card design the red and black wires that go to the switch are soldered on the brush card.

On the new brush card design the red and black wires that go to the switch are secured to the brush card with spring washers and screws.

The new brush card design is **directly interchangeable** in tools that have the old brush card design.

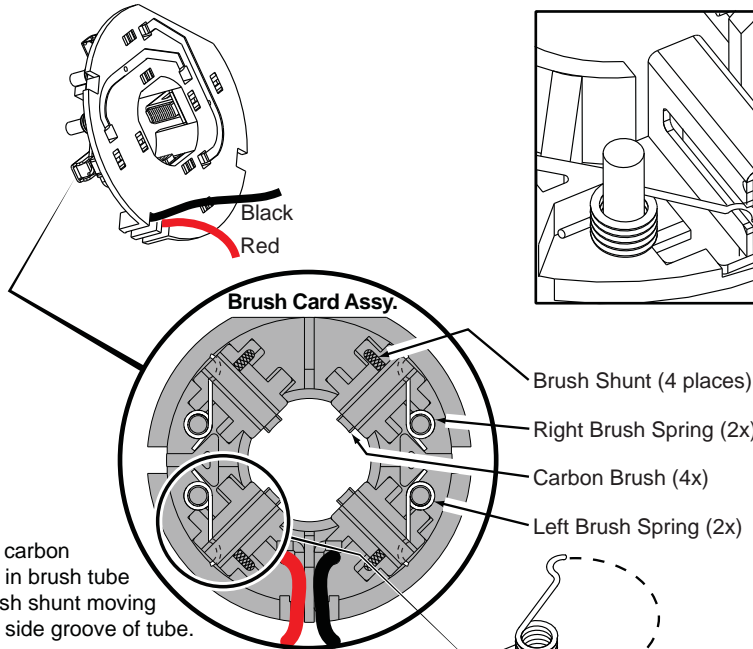

Be sure carbon brush is in brush tube with brush shunt moving freely in side groove of tube.

Place brush spring over post with short leg positioned downward as shown. Be sure spring is completely down with short leg trapped against 'Y' shaped wall on brush card.

While holding spring in place, bring the long leg of spring over the brush tube and through rear opening of tube. Position rounded hook of spring in groove on back of carbon brush. Be sure to check for free movement between carbon brush, brush shunt and brush spring.

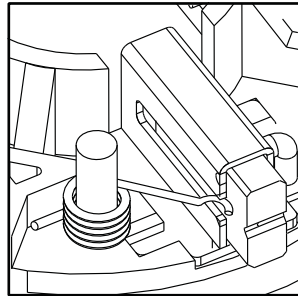

**NOTE:**  
As an aid to prevent damage to the armature commutator or the brushes when removing and installing the armature assembly, it is recommended to pull the carbon brushes partially back into the brush tube. The carbon brushes will be held in place with the brush spring moving from the rear of the brush to the side of the brush.

In the unlikely event that the spring pops off follow the instructions below.

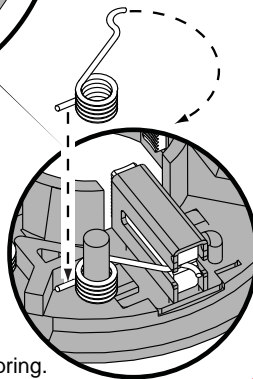

Wrong



Correct

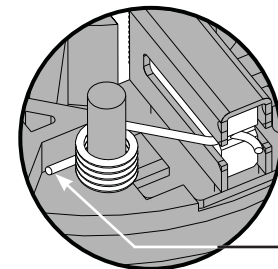

Short leg of spring to the bottom

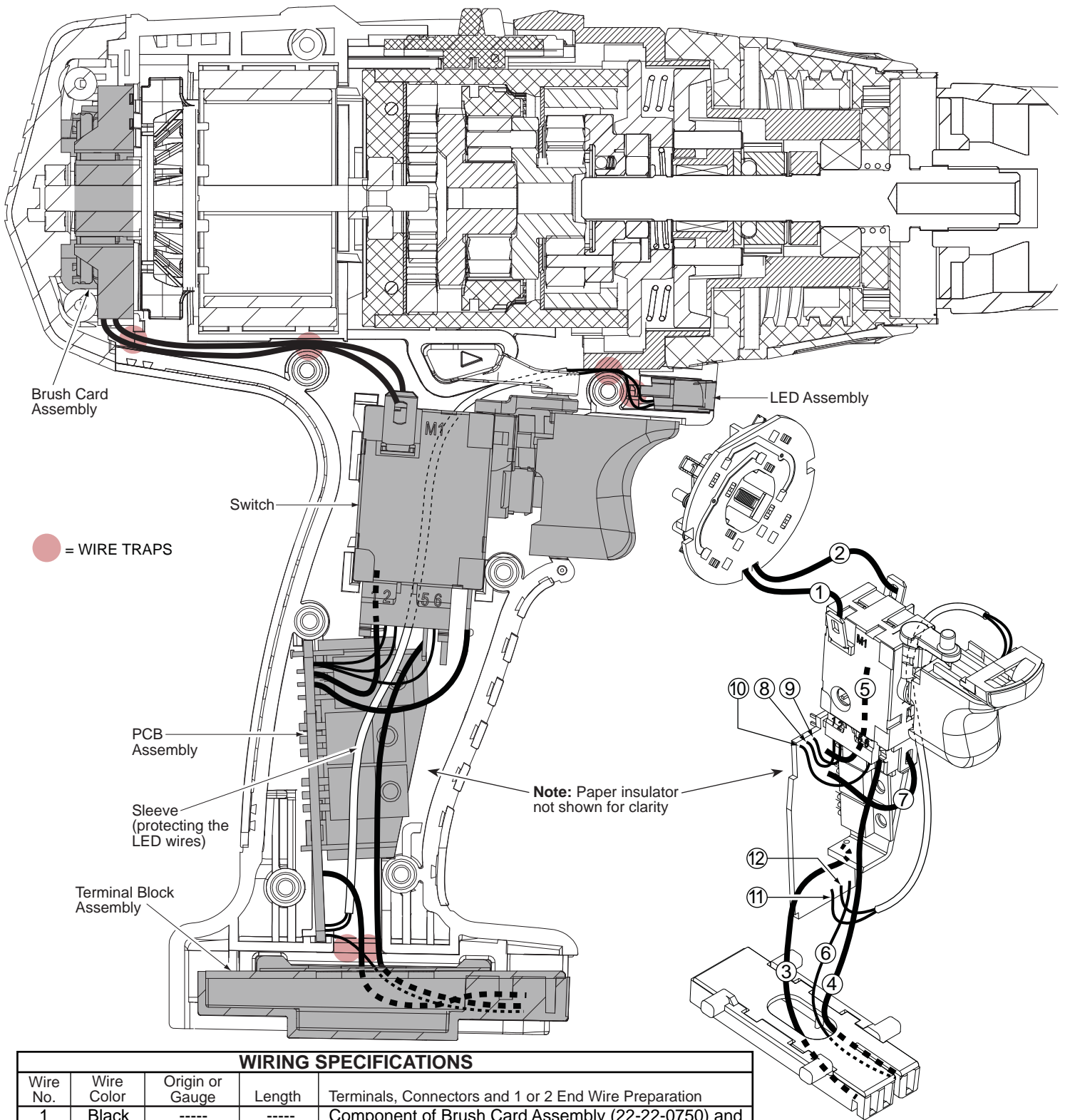

**WIRING SPECIFICATIONS**

Wire No.	Wire Color	Origin or Gauge	Length	Terminals, Connectors and 1 or 2 End Wire Preparation
1	Black	----	----	Component of Brush Card Assembly (22-22-0750) and the Switch/Brush Card Assembly (23-66-1335).
2	Red	----	----	
3	Black	----	----	Component of the Switch/Brush Card Assembly (23-66-1335), which contains the switch, brush card, PCB assembly, LED, terminal block, paper insulator and insulating sleeve.
4	Red	----	----	
5	White	----	----	
6	Red	----	----	
7	Blue	----	----	
8	Green	----	----	
9	Blue	----	----	
10	Black	----	----	
11	Red	----	----	
12	White	----	----	