

VENTIS™ MX4

Product Manual

Set-up
Operation
Service



Part Number: 17152357-1
Version 15

**INDUSTRIAL
SCIENTIFIC**

www.indsci.com

Contents

▶ Copyright Notice	4
▶ Warnings and Cautionary Statements.....	4
General.....	4
Personnel	4
Hazardous Conditions, Poisons, and Contaminants	4
General Usage	5
Agency-issued Conditions of Use and Warnings.....	5
Recommended Practices	6
▶ Ventis MX4 Resources	6
▶ Ventis MX4 Capabilities.....	7
▶ Unpacking the Monitor.....	7
Contents	7
Hardware Features and Functions.....	8
Display Screen	9
Alarms	11
▶ Monitor Set-up	14
Batteries	15
Docking Stations, Chargers, and other Accessories	15
Battery Charging	16
Power-on and -off.....	16
Configuration	18
Instructions	19
▶ Monitor Use and Service	27
Zero, Calibration, and, Bump testing	27
Procedures.....	27
Recommendations	27
General information.....	28
Instructions	28
Supplies.....	29
Remote Sampling.....	35
Cleaning	36
Service	36
Aspirated Monitor	37

Diffusion Monitor 39

Sensor, Sensor Barrier, LCD, and vibrating motor replacement 40

Battery Configuration 45

► Products, Specifications, and Certifications 47

 Ventis MX4 Accessories and Parts 47

 Monitor Specifications 47

 Battery Specifications 48

 Operating Conditions 48

 Cold-weather Operation 48

 Storage Conditions 48

 Sensor Specifications 49

 Toxic Gas Sensor Cross-sensitivity Table 49

 LEL, and LEL Correlation Factors for Combustible Gases 50

 Certifications 51

► Warranty 53

 Limitation of Liability 53

Contact Information 54

► Copyright Notice

Ventis MX4™ and Ventis™ are trademarks of Industrial Scientific Corporation.









All trademarks and registered trademarks are the property of their respective owners.















These help materials or any part thereof may not, without the written consent of Industrial Scientific Corporation, be copied, reprinted, or reproduced in any material form including but not limited to photocopying, transcribing, transmitting, or storing it in any medium or translating it into any language, in any form or by any means, be it digitally, electronic, mechanical, xerographic, optical, magnetic, or otherwise.









The information contained in this document is proprietary and confidential and all copyright, trademarks, trade names, patents, and other intellectual property rights in the documentation are the exclusive property of Industrial Scientific Corporation unless otherwise specified. The information (including but not limited to data, drawings, specification, documentation, software listings, source or object code) shall not at any time be disclosed directly or indirectly to any third party without prior written consent.

The information contained herein is believed to be accurate and reliable. Industrial Scientific Corporation accepts no responsibility for its use by any means or in any way whatsoever. Industrial Scientific Corporation shall not be liable for any expenses, costs by damage that may result from the use of the information contained within this document. Although every effort is made to ensure accuracy, the specifications of this product and the content herein are subject to change without notice.

► Warnings and Cautionary Statements

General	
	IMPORTANT Failure to perform certain procedures or note certain conditions may impair the performance of this product. For maximum safety and optimal performance, please read and understand the Ventis MX4 Product Manual available online at the Ventis MX4 Resource Center at www.indsci.com/ VentisMX4resources .
Personnel	
	CAUTION: For safety reasons, this equipment must be operated and serviced by qualified personnel only. Read and understand the product manual completely before operating or servicing.
Hazardous Conditions, Poisons, and Contaminants	
	WARNING: Servicing the unit, replacing or charging batteries, or using the communications port must only be done in an area known to be nonhazardous. Not for use in oxygen-enriched atmospheres.
	WARNING: Power-off the monitor before servicing the unit or replacing the battery.
	WARNING: Substitution of components may impair intrinsic safety and may cause an unsafe condition.
	CAUTION: High off-scale readings may indicate explosive gas concentration(s).
	CAUTION: Any rapid up-scale reading followed by a declining or erratic reading may indicate gas concentration(s) beyond the upper scale limit which may be hazardous.
	Silicone compound vapors or other known contaminants may affect the combustible gas sensor and cause readings of combustible gas to be lower than actual gas concentrations. If the monitor has been used in an

	area where silicone vapors were present, always calibrate the monitor before next use to ensure accurate measurements.
General Usage	
	Oxygen-deficient atmospheres may cause combustible gas readings to be lower than actual concentrations.
	Oxygen-enriched atmospheres may cause combustible gas readings to be higher than actual concentrations.
	Sudden changes in atmospheric pressure may cause temporary fluctuations in the oxygen reading.
	Verify the calibration of the combustible gas sensor after any incident where the combustible gas content has caused the monitor to display an over-range condition.
	Sensor openings, water barriers, and the pump inlet must be kept clean. Obstruction of the sensor openings or pump inlet and/or contamination of the water barriers may cause readings to be lower than actual gas concentrations.
	To avoid the potential of liquid being pulled into the sample tubing and pump assembly, it is recommended that Industrial Scientific filter (P/N 17027152) be used on the sample tubing when drawing samples using the aspirated monitor.
	WARNING: INSERT THE ALKALINE BATTERIES WITH THE CORRECT POSITIVE “+” AND NEGATIVE “-” ORIENTATION. WARNING: The Ventis MX4 is only approved for use with AAA battery types Energizer EN92 and Duracell MN2400. Do NOT mix battery types.
	WARNING: The use of leather cases can produce inaccurate readings with diffusion (non-aspirated) gas detection instruments for specific monitoring applications. Leather cases should be used ONLY as carrying cases, and NOT for continuous monitoring, with diffusion instruments configured to measure gases other than O₂, CO, CO₂, H₂S, and combustible gases (LEL/CH₄).
Agency-issued Conditions of Use and Warnings	
	Ensure all part-use restrictions (e.g., battery) meet any agency-mandated conditions of use.
	Ensure all instrument-configurable settings (e.g., always-on setting) meet any agency-mandated conditions of use. When using instrument-compatible Industrial Scientific docking stations, maintain mandated settings through the software (e.g., iNet Control or Accessory Software) or by manually configuring the instrument settings after docking.
	The Ventis MX4 is CSA certified according to the Canadian Electrical Code for use in Class I, Division 1 and Class I, Zone 1 Hazardous Locations within an ambient temperature range of T _{amb} : -20°C to +50°C. CSA has assessed only the %LEL combustible gas detection portion of this instrument for performance according to CSA Standard C22.2 No. 152. This is applicable only when the monitor is used in the diffusion mode and has been calibrated to 50% LEL CH ₄ , and when the monitor is used in the aspirated mode with an Extended range lithium-ion battery and has been calibrated to 50% LEL CH ₄ .
	CAUTION: CSA C22.2 No. 152 requires before each day's usage, sensitivity must be tested on a known concentration of pentane or methane equivalent to 25% or 50% of full scale concentration. Accuracy must be within -0% to +20% of actual concentration. Accuracy may be corrected by referring to the zero/calibration section of the Product Manual.
	The equipment complies with the standards IEC 60079-29-1 and EN 60079-29-1 for methane, propane, and hexane with the following exception: as for the methane (mine) detector, the battery run time was verified to be seven (7) hours rather than the eight (8) hours recommended by the standards, respectively.
	MED-certified instruments may be used only when configured and maintained to disallow power-off when the unit is in alarm.
	The Mine Safety and Health Administration (MSHA) has approved the Ventis MX4 as a Permissible Multi-Gas Monitor with the following warnings:

	<ul style="list-style-type: none"> MSHA approved for use with either the P/N 17134453-X2, 3.7 volt, Lithium-ion battery or P/N 17148313-2, 3.7 volt, lithium-ion Extended battery only. The battery pack is not user-replaceable. The monitor battery and the lithium battery on the main PCB are technician replaceable only. Charge rechargeable lithium-ion batteries with an ISC battery charger designed for use with this monitor in fresh air locations only. The monitor is to be calibrated according to the procedures in the instruction manual only. The aspirated version of the Ventis MX4 is only approved for use with the Extended range battery only. The monitor must display methane in the percent-by-volume mode (0-5%) for compliance determinations required by 30 CFR Part 75, subpart D.
	<p>SANS 1515-certified units may be used only as follows:</p> <ul style="list-style-type: none"> Diffusion applications Configured and maintained to disallow power-off when the unit is in alarm The Methane alarms are set as follows: low alarm = 1%vol and high alarm =1.4%vol With approved Lithium-ion batteries (see Ventis MX4 Accessories and Parts in this manual).
Recommended Practices	
	<p>Industrial Scientific Corporation recommends the monitor be fully charged (when equipped with a rechargeable battery), configured, and calibrated before first time use. If the lithium-ion battery is deeply discharged, it can take up to an hour for the instrument display to indicate that the battery is charging. Monitors used infrequently should be fully charged every four months.</p>
	<p>No part of the unit should be covered by any garment, part of a garment, or other item that would restrict the flow of air to the sensors or impair the operator's access to the audible, visual, or vibration alarms.</p>
	<p>Industrial Scientific Corporation recommends a full monitor calibration be performed monthly (at a minimum), using a certified concentration(s) of Industrial Scientific calibration gas(es) to help ensure monitor accuracy.</p>
	<p>Industrial Scientific Corporation recommends the monitor be zeroed and bump tested before each use with a certified concentration(s) of Industrial Scientific calibration gas(es).</p>
	<p>Battery contacts are exposed on batteries when they are removed from the monitor. Do not touch the battery contacts and do not stack batteries on top of one another.</p>
	<p>When reassembling the instrument or installing a battery pack, maintain ingress protection by tightening each fastener to its stated torque value (see the “Ventis MX4 Monitor three-Dimensional Diagram” and its key in this manual).</p>
	<p>Contact your service representative immediately if you suspect that the Ventis MX4 is working abnormally.</p>

► Ventis MX4 Resources

The Ventis MX4 Product Manual is the primary resource, within a full suite of learning tools, developed for the monitor user. Its step-by-step “walk through” format covers everything from unpacking to set-up, operation, and service. **All Ventis MX4 users should read and understand the Product Manual** prior to unpacking or using the monitor.

Ventis MX4 product-specific resources are part of the organization's broader *training* line-up, featuring online training modules and face-to-face classroom programs for technicians, operators, first responders, trainers, and distributors. Courses combine theory with hands-on learning, and can be tailored to the customer's unique requirements and gas monitoring applications.

The organization's *customer and technical support* call centers provide product and order information, how-to product assistance, and guidance for in-depth technical applications. Its *service centers* offer comprehensive factory repair and maintenance services.

Industrial Scientific Corporation provides a full suite of resources to aid customers in the competent and safe use of its products and services. With 19 manufacturing, support, and service centers and hundreds of distributors worldwide, Industrial Scientific serves the globe's gas detection needs.

► Ventis MX4 Capabilities

The Ventis MX4 is a *portable* multi-gas monitor. Offered as a *diffusion* monitor, it detects and measures gas(es) present in open space. To enable monitor use within confined space locations, the Ventis MX4 is also offered as an *aspirated* monitor. A pump module and battery accessories enable the conversion of either monitor for dedicated use in either confined or open spaces.

Based on the customer's monitor order, up to four sensors are factory installed enabling the monitor to continuously and simultaneously detect and measure the presence of up to four specific gases.

Sensor Category	Number available per monitor	Gases Monitored
Oxygen	1	O ₂ (Oxygen) only
Combustible	1	Monitor can be configured for sensor to measure ONE of the following: <ul style="list-style-type: none"> • LEL (Pentane) • LEL (Methane) • CH₄ (0%-5%)
Toxic	2	Each sensor detects and measures only ONE of the following: <ul style="list-style-type: none"> • CO (Carbon Monoxide) • CO/H₂ Low (Carbon Monoxide with low H₂ interference) • H₂S (Hydrogen Sulfide) • NO₂ (Nitrogen Dioxide) • SO₂ (Sulfur Dioxide)

Equipped with a multi-mode (audible, visual, and vibration) and multi-level *alarm system*, the Ventis MX4 monitor is capable of notifying its user of potentially hazardous gas concentrations.

The monitor performs continuous *data logging* at 10 second intervals. It can store approximately 90 days of data for a four-sensor configuration. Its date- and time-stamped event log records and stores data for the following: 60 alarm events, 30 error events, and 250 manually performed calibrations or bump tests. The memory, when full, overwrites the oldest data as the newest readings and events are logged.

The Ventis MX4 monitor functions as an independent device to monitor the environment for hazardous gas concentrations. It is compatible with products that charge, calibrate, bump test, read and record instrument data, protect, and otherwise enable or enhance use of the monitor and its data. For a complete list of these products, please refer to the manual section, [Ventis MX4 Accessories and Parts](#).

► Unpacking the Monitor

Contents

The monitor box contains the following items including, when ordered, those marked optional. Each item ordered should be accounted for in the unpacking process.

Quantity	Item	Notes
1 as ordered	Ventis MX4 Portable Multi-gas Monitor	The monitor type is indicated on the box label. Options: <ul style="list-style-type: none"> • Ventis MX4 Diffusion • Ventis MX4 Aspirated • Ventis MX4 Aspirated with Conversion Kit
1	Ventis MX4 Quick start guide	Review for important safety information before using the monitor.
1 installed as ordered	Battery	One of four battery types are factory installed as indicated on the box label.

Quantity	Item	Notes
		Options: <ul style="list-style-type: none"> • Rechargeable Lithium-ion (Li-ion) • Rechargeable Slim extended lithium-ion (Li-ion) • Rechargeable Extended range lithium-ion (Li-ion) • Replaceable Alkaline
1 as ordered	Ventis Charger	Universal power cord. AC charger products include interchangeable plugs (US, UK, EU, and AUS).
0 or 1	Calibration Cup	Diffusion – 1 included Aspirated – 0 included
1	Calibration and Bump Test Tubing	Diffusion – two feet of clear tubing
0 or 1	In-field Sampling Tubing	Diffusion – 0 included Aspirated – Ten feet of black tubing
1	Final Inspection & Test Report	Contains the following factory set* information: <ul style="list-style-type: none"> • Monitor Set-up Date • Monitor Part Number (P/N) • Monitor Serial Number (S/N) • For Each Sensor*: <ul style="list-style-type: none"> • P/N • S/N • Type • Location • Alarm level values • Span gas values • Span reserve values *Some factory set sensor values subject to user changes.
1	Warranty Card	--

After unpacking, if any item is missing or appears to have been damaged, contact a local distributor of Industrial Scientific products or Industrial Scientific Corporation (for contact information, please see the manual's last page).

► Monitor Overview

Hardware Features and Functions

The monitor's *case top* (front of monitor) has two main sections. As shown below, the upper section contains the sensor ports. The lower section houses the user interface features, a *LCD display screen* and two *buttons*. Each feature's general functions are noted below. As shown, the diffusion and aspirated monitors differ with respect to the location of the air intake mechanism and visual alarm indicators.

The instrument may be used in any orientation when clipped to the user or when used with a compatible carrying case. Normal instrument orientation for measuring gas concentration is hand held with sensors and display facing the operator.



Number	Feature	Functions
1	Visual alarm indicator	Signals an alarm or warning; frequency varies by alarm level. Also used as a confidence indicator.
2	Pump inlet (aspirated) Sensor ports (diffusion)	Air intake; calibration and bump test gas intake.
3	LCD display	User interface; backlight flashes when monitor is in system, high, or low alarm states.
4	Audible alarm ports	On when monitor is in system, high, or low alarm states; frequency and tone vary by alarm level. Also used for warnings and as confidence indicator.
5	On/Off/Mode button	Used to power-on and power-off. Also used to bypass a process/step or advance to a next screen in both gas monitoring and configuration modes. Sets values in configuration mode.
6	Enter button	Used to begin a process/step in a process. Edits values in configuration mode.
7	IrDA interface	Indicates infrared light data exchange in-progress.
8	Charging contacts	Battery charging.





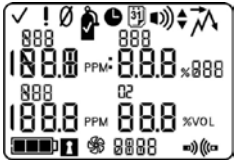
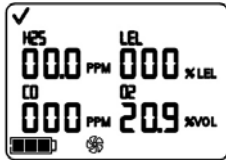

Display Screen

The Ventis MX4 *Boot-up Screen*, as shown below, serves to introduce all icons and the alpha-numeric items (e.g., 8.8.8) that can appear on the display when the monitor is in use, docked, or charging. Each display item is stationary, communicates unique information, and appears only when relevant to the task being performed.





A sample *Gas Monitoring Screen* is also shown below, next to the boot-up screen. This illustrates how the icons and the alpha-numeric characters work together to communicate several points of information to the monitor user.

 <p>Boot-Up Screen All possible screen images.</p>	 <p>Gas Monitoring Screen Sample screen in gas monitoring mode.</p> <p>NOTE: Display screens featured throughout this manual include the “pump” icon. Similar in appearance to a fan, it indicates an aspirated monitor is in use. For a diffusion monitor, the pump icon does not appear on the display.</p>
--	---

It is helpful to view the boot-up screen in sections. The top and bottom rows each contain icons. The main function of the middle section, in *gas monitoring mode*, is to communicate gas concentration readings. Definitions for all icons, gas name abbreviations, gas measurement units, and other indicators are provided below. Where applicable, display variations are noted.

Top Row Icons	Definition
✓	Status: indicates no monitor or sensor faults.
!	Warning: indicates monitor or sensor fault.
∅	Zero: communicates zero status (e.g., zero results, zero in-progress, etc.).
	Gas Cylinder: communicates calibration related information (calibration due, calibration apply gas, etc.).
	Clock: indicates a process is in-progress.
	Calendar: communicates overdue warnings for service items (calibration, bump testing, etc.).
	Alarm: indicates an alarm causing condition.
	Low level audio alarm is on.
	High level audio alarm is on.
	Peak: displayed when peak detection values are viewed.

Alpha-numeric display values	Definition
CO	Carbon Monoxide (CO)
CH4	Methane (CH ₄)
SO2	Sulfur Dioxide (SO ₂)
LEL	Lower Explosive Limit. Display variations: “LEL” (English) “LIE” (French) “UEG” (German)
O2	Oxygen (O ₂)
NO2	Nitrogen Dioxide (NO ₂)

Alpha-numeric display values	Definition
H ₂ S	Hydrogen Sulfide (H ₂ S)
CO _L	CO H ₂ /Low
%VOL	Percentage Volume: O ₂ and CH ₄ measurement unit
%LEL	Percentage unit for combustible gases; display variations: “%LEL” (English) “%LIE” (French) “%UEG” (German)
PPM	Parts Per Million: H ₂ S, CO, SO ₂ and NO ₂ measurement unit.
Or	Over-range: for any sensor in over-range, indicates the measured gas concentration is greater than the measurement range of the sensor. Display variations: “Or” (English and German) “Sup” (French)
-Or	Negative Over-range: for any sensor in negative over-range indicates the measured gas concentration is less than the negative measurement range of the sensor. Display variations: “-Or” (English and German) “InF” (French)
Bottom Row Icons	Definition
	Battery level indicator; display variations: Empty battery icon with three dashes in place of each sensor reading = critical battery warning Flashing empty battery icon = low battery warning 1 black bar = < 33% charge remaining 2 black bars = 34% – 66% charge remaining 3 black bars = 67% – 100% charge remaining
	Security Code: indicates code is set or to be entered.
	Pump: shown anytime an aspirated monitor is in use.
	Indicates IrDA communication is in-progress.
STEL	Short Term Exposure Limit: communicates STEL values. Display variations: “STEL” (English and German) “VLE” (French)
TWA	Time Weighted Average: communicates TWA values. Display variations: “TWA” (English and German) “VME” (French)



Alarms



NOTICE

- All monitor alarms and warnings should be taken seriously and responded to as stated in company safety standards.
- Once initiated, an alarm will remain on while the alarm condition is present. For gas-related alarms, once the detected gas concentration changes, the alarm indicators will change to reflect any new condition such as low-alarm gas, high-alarm gas, over-range gas, or no gas alarm.
- When the latch alarm feature is enabled and the monitor goes into alarm, it will remain in alarm until the alarm condition no longer exists *and* the monitor user presses the ENTER button for one second. This applies only to gas-related alarms.

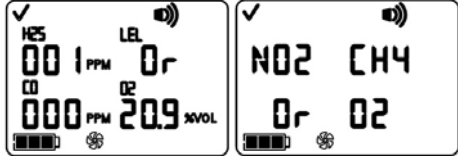
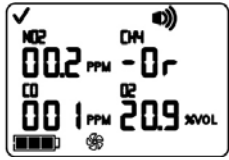
It is practical for the monitor user to be aware of the possible alarms prior to monitor set-up and use. The Ventis MX4 has four alarm and warning levels. A “system level” alarm generates the highest frequency tone and highest level visual and vibration signals. It is used to indicate such events as a pump, critical battery failure, or sensor failure. The “high” or “low” level audio alarms, in combination with visual and vibration indicators, turn on when gas concentration readings are over-range, high, or low. The lowest level indicator is a warning with beep patterns to indicate service needs (e.g., low battery or calibration due). The beep is also used as a confidence indicator when enabled.

Alarm types and their alarm generating conditions are described below.

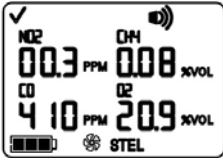
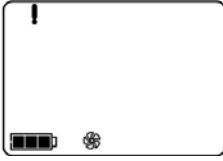
Display	Description
 <p>Over-range Alarm Screen The “Or” message indicates which sensor(s) is reading an over-range condition(s). All other sensors show their current gas concentration readings on a numeric display (left) or gas names on a text display (right). The high level alarms turn on and the alarm icon displays.</p>	<p>An over-range condition occurs when the gas concentration value sensed is above the sensor’s measuring range.</p> <p>After any over-range alarm, the monitor should be calibrated.</p> <p><i>NOTES:</i> The O₂ and toxic sensor values normally reset when the gas sensed reaches an acceptable range.</p> <p>If the LEL reads over-range, the alarm latches and the LEL sensor is automatically turned off. Press the enter button to turn on the LEL sensor. This will turn off the alarm indicators. After a warm-up period of approximately 30 seconds, an LEL reading will display. If the new reading is an over-range or other alarm condition, the alarm indicators will turn on.</p>
 <p>Negative Over-range Alarm Screen The “-Or” message indicates which sensor is reading a negative over-range condition. All other sensors display their current gas concentration readings*. The high level alarms turn on and the alarm icon displays.</p>	<p>A negative over-range condition occurs when the gas concentration value sensed is less than the sensor’s measuring range.</p> <p>After any negative over-range alarm, the monitor should be calibrated.</p>
 <p>High Alarm Screen A flashing gas concentration value* indicates which sensor(s) reading(s) is the cause for alarm. The high level alarms turn on and the up arrow icon displays.</p>	<p>A high alarm condition occurs when the concentration of gas sensed reaches a level greater than the monitor’s high alarm value setting for a sensor(s).</p>
	<p>A low alarm condition occurs when the concentration of gas sensed reaches the monitor’s low alarm value setting for a sensor(s).</p>

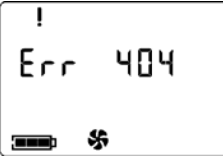
Display	Description
<p>Low Alarm Screen A flashing gas concentration value* indicates which sensor(s) reading(s) is the cause for alarm. The low level alarms turn on and the down arrow icon displays.</p>	
 <p>TWA Alarm Screen A flashing gas concentration value* indicates which sensor(s) reading(s) is the cause for alarm. The low level alarms turn on and the TWA icon flashes.</p>	<p>A TWA alarm occurs when the calculated time weighted average reaches the monitor's hazardous value for the set time frame.</p>
 <p>STEL Alarm Screen A flashing gas concentration value* indicates which sensor(s) reading(s) is the cause for alarm. The low level alarms turn on and the STEL icon flashes.</p>	<p>The STEL alarm occurs when the short term exposure value exceeds the acceptable limit.</p>
 <p>No Sensor Installed Screen The system level alarms turn on and the error icon displays.</p>	<p>Alarm occurs when the monitor registers no sensors installed.</p>
 <p>Sensor Data Fail Screen A flashing "F" indicates which sensor is the cause for alarm. The audio alarm turns on and the error icon displays.</p>	<p>Alarm occurs when any installed sensor's data-related operations fail and the sensor is not operational.</p>
 <p>Critical Error Screen</p>	<p>Error codes 4XX to 5XX (404 shown here) indicate the monitor has detected a malfunction. The unit is not operational and should be examined by a qualified technician or reported to Industrial Scientific for service or repair information.</p>

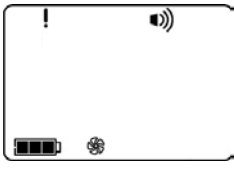
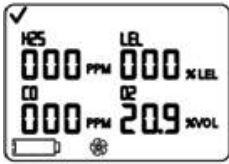
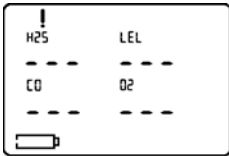
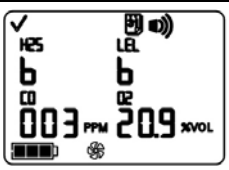
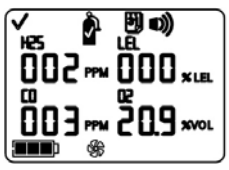
Display	Description
 <p>Pump Fault Alarm The system level alarms turn on and the error icon displays.</p>	<p>Alarm occurs when, if attached, the pump is not operating correctly. While in alarm, every ten seconds the monitor attempts to restart the pump. If unsuccessful, the monitor remains in alarm.</p> <p><i>Note:</i> The nominal flow rate is >200 cc/m (.2 LPM). A pump fault alarm will occur when the flow is less than 200 cc/m +0, -25%.</p>
 <p>Low Battery Warning Screen A beep sounds every 60 seconds and the empty battery icon flashes.</p>	<p>Alarm occurs when the monitor's battery reaches a low level of charge or is nearing its end of life.</p>
 <p>Critical Battery Alarm The empty battery icon indicates a battery life warning, while three dashes display in place of each sensor reading. The high alarm sounds for 10 minutes before powering off the monitor.</p>	<p>This alarm occurs when there is not enough battery life remaining for continued operation. The battery must be charged or replaced. <i>The instrument is NOT detecting gas at this time.</i></p>
 <p>Bump Overdue Screen A "b" indicates which sensor(s) is overdue for bump testing. Two beeps sound every 30 seconds and the calendar and alarm icons display.</p>	<p>Alarm occurs when one or more sensors are due for a bump test. If the monitor settings permit, an in-field bump test may be performed in an area known to be nonhazardous.</p>
 <p>Calibration Due Alarm Screen The gas value flashes for each sensor overdue for calibration. Three beeps sound every 30 seconds and the calendar and alarm icons display. The gas cylinder icon flashes.</p>	<p>Alarm occurs when one or more sensors are due for calibration. If the monitor settings permit, an in-field calibration can be performed in an area known to be nonhazardous.</p>
<p>* The numeric mode display shows gas concentration values; the text mode display shows gas type names in place of gas values.</p>	





► **Monitor Set-up**

Preparing the monitor for first time use is a “3-C” process: *charge* (if equipped with a lithium-ion battery), *configure*, and *calibrate*. This manual section covers charging and configuration for set-up purposes and can be consulted for ongoing instruction thereafter. Immediately following this section, calibration is covered in the manual section, Use and Service.

Batteries

As shown below, the Lithium-ion and Slim extended lithium-ion batteries are compatible with the diffusion instrument only. The Extended range battery can be installed for use with a diffusion or aspirated instrument. The battery's orderable part numbers are supplied in *Battery part numbers and options*.

Battery Compatibility

	Lithium-ion battery (VTSB-1XY*)	Rechargeable (part number*) Slim extended lithium-ion battery (VTSB-4XY*)	Extended range lithium-ion battery (VTSB-2XY*)	Replaceable (part number*) Alkaline battery (VTSB-3XY*)
				
Ventis MX4 diffusion	Yes	Yes	Yes	Yes
Ventis MX4 aspirated	No	No	Yes (without cover)	Yes (without cover)

*X indicates color and Y indicates approvals.

Docking Stations, Chargers, and other Accessories

Fully charge the monitor before first use. The lithium-ion equipped Ventis MX4 can be charged using any of the products listed below.

Part Number	Product
Docking Stations	
18109327	DSX™ Docking Station for Ventis
Calibration Stations	
18108631	V-Cal™ Calibration Station
18107664	V-Cal™ 6-Unit Calibration Station
Chargers	
18108191	Ventis Single Unit Charger
18108209	Ventis Single Unit Charger / Datalink
18108650	Ventis 6-Unit Charger
18108651	Ventis Single Unit Automotive Charger, 12 VDC
18108652	Ventis Single Unit Truck-Mount Charger, 12 VDC, with Cigarette Adapter

Part Number	Product
18108653	Ventis Single Unit Truck-Mount Charger, 12 VDC, Hard Wired

NOTE: The above products are all equipped with a yellow LED “presence” indicator. This LED confirms that the monitor is properly seated in the cradle such that the monitor can charge; however, it is NOT intended to be used as a charging indicator. This LED indicator may go out intermittently during normal charging functions and will not light if the unit is fully charged when placed in the cradle. Always refer to the monitor display’s battery level indicator to confirm the battery charge level.

Battery Charging

Charger insert placement

If the charger includes an insert, adjust the insert’s position to ensure the battery contacts touch the charging contacts.



Lithium-ion battery

Insert side 1: forward position



Slim extended lithium-ion battery

Insert side 2: forward position



Extended range lithium-ion battery

Insert side 1: Rear position





Once the insert is placed into the desired position, a firm push down will secure it in place.

To prevent losing the insert, keep it in the cradle in the most often used position.

NOTE: Do NOT touch the battery contacts located at the front of the charger as contaminants and damage will inhibit the battery’s ability to charge.

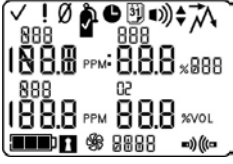
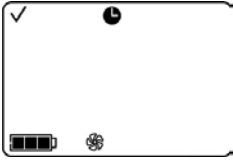
Power-on and -off

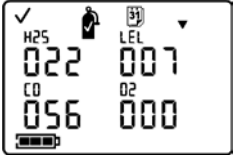
To power-on the Ventis MX4, **press ON/OFF/MODE** and hold for three to five seconds. During the first ten to 15 seconds the monitor is on, its firmware completes internal tests and the user sees or hears what is described and shown below. Following this initialization phase, a countdown screen displays. During this 20-second countdown, the monitor user can enter configuration mode to manually adjust monitor settings.

Display and Options	Instructions
 <p>Visual Test Screen Displays for up to five seconds as the monitor completes a sensor and alarm check. Visual, vibration, and audio alarms turn on briefly, then off.</p>	<p>No user action required.</p>
 <p>Pump Set-up Screen Displays for five to seven seconds for an aspirated monitor. The monitor checks for the presence of a pump. If present, the pump is started and, if needed, adjusted for optimum flow.</p>	<p>Be sure the pump inlet is not blocked.</p>
 <p>Software Version Screen The Software Version Screen message displays for five seconds.</p>	<p>No user action required.</p>
 <p>Calibration Days Screen When the up arrow (▲) is featured, the number of days displayed for each sensor indicates when the <i>next</i> calibration is due. When the down arrow (▼) is featured, the number of days displayed indicates when the <i>last</i> calibration occurred.</p>	<p>No user action required.</p>
 <p>Countdown Screen Displays the 20 second countdown, one second at a time, from 20 to one. Options : Enter gas monitoring mode Enter configuration mode</p>	<p>To enter gas monitoring mode: allow the countdown to complete and advance to the Gas Monitoring Screen. Proceed to the manual section, <u>Monitor Use and Service</u>.</p> <p>To enter configuration mode: simultaneously press ON/OFF/MODE and ENTER, hold for three seconds, and release.</p>

Display and Options	Instructions
 <p>Power-Off Screen The screen displays a five-second countdown accompanied by five beeps and LED flashes.</p>	<p>Press ON/OFF/MODE, hold for the full five second countdown to zero, and release to power-off the monitor.</p>

Configuration

Introduction

Before first time use of the monitor, its settings should be reviewed and, if needed, be adjusted. Qualified safety personnel should complete the following tasks.

- Review the monitor settings for compliance with company policy and any applicable regulations, laws, and observed guidelines as issued by regulatory agencies and government or industry groups.
- Determine which settings, if any, require adjustment.
- Make the adjustments or supervise other qualified personnel in the process.
- When using instrument-compatible Industrial Scientific docking station software (e.g., iNet, Docking Station Server Administrative Console [DSSAC], or Accessory Software), maintain the mandated settings through the software or by manually configuring the instrument settings after docking.

Monitor settings should be reviewed regularly and adjusted as needed. The following settings are adjustable or “configurable” for the Ventis MX4.

- LEL Type
- Calibration Mode Setting
- Low Alarm Settings
- High Alarm Settings
- TWA Alarm Settings
- TWA Interval Settings
- STEL Alarm Setting
- Calibration Gas Settings
- Clock Settings
- Date Settings
- Display Mode Setting
- Confidence Indicator (on/off)
- Confidence Indicator (type)
- Bump Test In-field
- Bump Test Due Warning
- Bump Test Time Set-point
- Bump Test Percentage
- Bump Test Response Time
- Alarm Latch Set
- Zero In-field
- Calibration In-field
- Calibration Due Alarm
- Calibration Due Set-point
- Security Code
- Language Selection
- Always-on Setting
- Shutdown In Alarm Setting
- Alarm on Dock Setting

The Ventis MX4 can be configured manually as instructed below. Any changes made take effect immediately upon exiting the configuration mode.

Instructions

NOTICES

- The configuration mode should be accessed only by safety personnel authorized to change monitor settings based on company policy.
- Read ALL requirements and instructions outlined below, including the screen-by-screen process description, before beginning the configuration process.

The configuration mode can be entered during the 20-second countdown of the power-on process. During the countdown, **simultaneously** press **ON/OFF/MODE** and **ENTER**, **hold** for three seconds, and **release** to enter configuration mode. (While in the configuration mode, the same button presses cause the monitor to exit configuration). Each configuration screen times out after 30 seconds and the monitor enters gas monitoring mode. To re-enter the configuration mode, power-off the monitor, then power-on and repeat the entry process.

Throughout the configuration process, the main functions of the two buttons are as follows.

- The ENTER button is used to *edit* values. It is also used, where noted, to begin a process or a step in a process.
- The ON/OFF/MODE button is used to *set* the value. Where noted, it is also used to bypass a process or step in a process, or to advance to the next configuration screen.



The first screen to display in configuration mode depends on three things:



- security code setting,
- the presence or absence of the China MA feature,
- and the presence or absence of an LEL sensor.



If the security code setting is 000, the security feature is disabled and the Enter Security Code Screen does NOT appear. If the security code is NOT 000, the security feature is enabled and the monitor displays the Enter Security Code Screen.



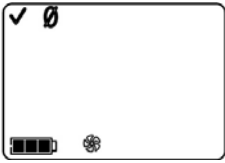

The monitor next checks for the presence of a China MA mining feature. If this feature is operational, the monitor displays the Zero Initiate Screen.

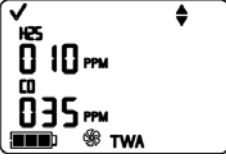

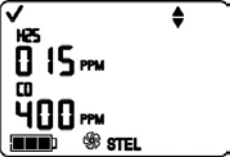

If the China MA mining feature is NOT operational, the monitor then checks for an installed LEL sensor. If installed, the monitor displays the LEL Type Screen. If no LEL sensor is installed, the monitor displays the Zero Initiate Screen.





Configuration Process	
Display and Options	Instructions
 <p>Enter Security Code Screen The presence of this screen indicates an enabled security feature.</p>	<p>Press ENTER to edit the value, if needed; press repeatedly or hold down to speed the increment pace to reach the valid security code. Press ON/OFF/MODE to enter configuration mode and arrive at the next applicable screen.</p>
 <p>LEL Type Set Screen Options</p>	<p>Press ENTER to edit the value, if needed. Press ON/OFF/MODE to set the value and advance to the Zero Initiate Screen.</p> <p><i>NOTE: If the LEL type is changed, the sensor goes into calibration fail mode. A full calibration is required before the monitor can be used and is accessible from the next screen in the configuration process, the Zero Initiate Screen. For complete calibration instructions, proceed to the manual section, <u>Zero Calibration, and Bump Testing</u>.</i></p>



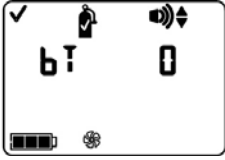

Configuration Process	
Display and Options	Instructions
<p>LEL CH₄</p>	
 <p>Zero Initiate Screen Options Bypass zero and calibration process. Begin zero and calibration process.</p>	<p>Press ON/OFF/MODE to bypass the zero and calibration processes and advance to one of two screens.</p> <p>If the installed sensor set includes H₂S <u>and</u> NO₂, OR, SO₂ <u>and</u> NO₂, the monitor is pre-set for standard calibration mode and the Low Alarm Set-point Screen displays.</p> <p>For all others installed sensor combinations, the Calibration Mode Selection Screen displays.</p> <p>Press ENTER to begin the zero and calibration process. Proceed to the manual section, <u>Zero, Calibration, and Bump Testing</u>.</p>
 <p>Calibration Mode Selection Options 0 = Standard Calibration 1 = Quick Calibration</p>	<p>The quick calibration option sets the monitor to calibrate all four sensors simultaneously. The standard calibration option sets the monitor to calibrate each sensor independently.</p> <p>Press ENTER to edit the value, if needed.</p> <p>Press ON/OFF/MODE to set the value and advance to the Low Alarm Set Screen.</p>
<p><i>NOTE: The user can edit the values for four alarm types in configuration mode. The monitor presents these options in the order shown below.</i></p> <ol style="list-style-type: none"> 1. Low alarm 2. High alarm 3. TWA (if toxic sensors installed) 4. STEL (if toxic sensors installed) <p><i>For each alarm type (e.g., low alarm), the user can edit the alarm settings for each installed sensor, one sensor at a time. The order in which the sensors are subject to change is as follows.</i></p> <ol style="list-style-type: none"> 1. Toxic sensor 1 2. LEL sensor 3. Toxic sensor 2 4. O₂ sensor 	
 <p>Low Alarm Set-point Screen Displays the existing low alarm value for each installed sensor. If any one of the sensors is NOT installed, its position on the display is blank.</p>	<p>Press ON/OFF/MODE to bypass the low alarm value set process and advance to the High Alarm Set-point Screen.</p> <p>Press ENTER to begin the low alarm value set process.</p> <p>On the display, the first sensor subject to change flashes.</p> <p>Press ENTER to edit the value, if needed; press repeatedly or hold down to speed the increment pace.</p> <p>Press ON/OFF/MODE to set the value.</p> <p>The next sensor subject to change flashes. Continue to use the ENTER and ON/OFF/MODE buttons, respectively, to edit and set each sensor's low alarm value.</p> <p>After the alarm value is set for each installed sensor, press ON/OFF/MODE to advance to the High Alarm Set-point Screen.</p>



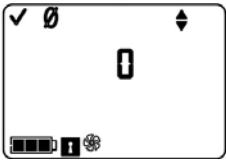

Configuration Process	
Display and Options	Instructions
 <p>High Alarm Set-point Screen Displays the existing high alarm value for each installed sensor. If any one of the sensors is not installed, its position on the display is blank.</p>	<p>Press ON/OFF/MODE to bypass high alarm value set process and advance to one of two screens as noted below. Press ENTER to begin the high alarm value set process. On the display, the first sensor subject to change flashes. Press ENTER to edit the value, if needed; press repeatedly or hold down to speed the increment pace. Press ON/OFF/MODE to set the value.</p> <p>The next sensor subject to change flashes. Continue to use the ENTER and ON/OFF/MODE buttons, respectively, to edit and set each sensor's high alarm value.</p> <p>After the alarm value is set for each installed sensor, press ON/OFF/MODE and advance to one of two screens. If at least one toxic sensor is installed, the TWA Alarm Set Screen displays.</p> <p>If NO toxic sensors are installed, the Calibration Gas Set Screen displays.</p>
 <p>TWA Alarm Set-point Screen Displays the existing TWA values for the toxic sensors installed. No other sensor readings appear.</p>	<p>Press ON/OFF/MODE to bypass the TWA alarm value set process and advance to the TWA Interval Set-point Screen. Press ENTER to begin the TWA alarm value set process. On the display, the first sensor subject to change flashes. Press ENTER to edit the value, if needed; press repeatedly or hold down to speed the increment pace. Press ON/OFF/MODE to set the value.</p> <p>The next sensor subject to change flashes. Continue to use the ENTER and ON/OFF/MODE buttons, respectively, to edit and set each alarm value.</p> <p>After the alarm value is set for each installed sensor, press ON/OFF/MODE to advance to the TWA Interval Set Screen.</p>
 <p>TWA Interval Set-point Screen Displays the existing TWA interval. The value can be set from one to 40 hours, in increments of one.</p>	<p>Press ENTER to edit the value, if needed. Press ON/OFF/MODE to set the value and advance to the STEL Alarm Set-point Screen.</p>

Configuration Process	
Display and Options	Instructions
 <p>STEL Alarm Set-point Screen Displays the existing STEL values for the toxic sensors installed. No other sensor readings appear.</p>	<p>Press ON/OFF/MODE to bypass the STEL alarm value set process and advance to the Calibration Gas Set Screen. Press ENTER to begin the STEL alarm value set process. On the display, the first sensor subject to change flashes. Press ENTER to edit the value, if needed; press repeatedly or hold down to speed the increment pace. Press ON/OFF/MODE to set the value.</p> <p>The next sensor subject to change flashes. Continue to use the ENTER and ON/OFF/MODE buttons, respectively, to edit and set each sensor's STEL alarm value.</p> <p>After the alarm value is set for each installed sensor, press ON/OFF/MODE to advance to the Calibration Gas Set Screen.</p>
 <p>Calibration Gas Set Screen Displays the existing calibration gas value for each installed sensor.</p> <p>If any one of the sensors is not installed, its position on the display is blank.</p>	<p>Press ON/OFF/MODE to bypass the calibration gas set process and advance to the Clock Set Screen. Press ENTER to begin the calibration gas value set process. On the display, the first sensor subject to change flashes. Press ENTER to edit the value, if needed; press repeatedly or hold down to speed the increment pace. Press ON/OFF/MODE to set the value.</p> <p>The next sensor subject to change flashes. Continue to use the ENTER and ON/OFF/MODE buttons, respectively, to edit and set each sensor's calibration gas value.</p> <p>After calibration gas value is set for each installed sensor, press ON/OFF/MODE to advance to the Clock Set Screen.</p>
 <p>Clock Set Screen Displays the existing time values using a 24-hour time format.</p>	<p>Press ON/OFF/MODE to bypass the clock set process and advance to the Date Set Screen. Press ENTER to begin the clock set process. On the display, the first time value subject to change flashes. Press ENTER to edit the value, if needed; press repeatedly or hold down to speed the increment pace. Press ON/OFF/MODE to set the value.</p> <p>The next value subject to change flashes. Use the ENTER and ON/OFF/MODE buttons, respectively, to edit the value.</p> <p>After all values are set, press ON/OFF/MODE and advance to the Date Set Screen.</p>
 <p>Date Set Screen Displays the existing date. The value displayed on the far left is the month and to its right the day. The year is displayed beneath the day.</p>	<p>Press ON/OFF/MODE to bypass the date set process and advance to the Display Mode Set Screen. Press ENTER to begin the date set process On the display, the first date value subject to change flashes. Press ENTER to edit the value, if needed; press repeatedly or hold down to speed the increment pace. Press ON/OFF/MODE to set the value.</p> <p>The next date value subject to change flashes. Continue to use the ENTER and ON/OFF/MODE buttons, respectively, to edit and set each value.</p> <p>After all values are set, press ON/OFF/MODE and advance to the Display Mode Set Screen.</p>

Configuration Process	
Display and Options	Instructions
 <p>Display Mode Set Screen Options 0 = Numeric Mode 1 = Text Mode</p>	<p>The display mode selected determines whether the monitor user will see a numeric or text display (including alarm displays) when the monitor is in the gas monitoring mode.</p> <p>Press ENTER to edit the value, if needed. Press ON/OFF/MODE to set the value and advance to the Confidence Indicator Set Screen.</p>
 <p>Confidence Indicator On-Off Screen Options 0 = Disable/off 1 = Enable/on</p>	<p>With an enabled confidence indicator, the monitor will emit a signal, every 90 seconds in gas monitoring mode, to inform the user it is operational.</p> <p>Press ENTER to edit the value, if needed. Press ON/OFF/MODE to set the value and advance to one of two screens.</p> <p>If the confidence indicator is enabled, the Confidence Indicator Type Set Screen displays.</p> <p>If the confidence indicator is disabled, the Bump Test In-field Option Screen displays.</p>
 <p>Confidence Indicator Type Set Screen Options 1 = audible chirp 2 = LED flash 3 = combination audible chirp and LED flash</p>	<p>Sets the type of signal that will be emitted by an enabled confidence indicator.</p> <p>Press ENTER to edit the value, if needed. Press ON/OFF/MODE to set the value and advance to the Bump Test In-field Option Screen.</p>
 <p>Bump Test In-field Option Screen Options 0 = Disable/off 1 = Enable/on</p>	<p>When enabled, permits all monitor users to bump test the monitor from the gas monitoring mode.</p> <p>Press ENTER to edit the value, if needed. Press ON/OFF/MODE to set the value and advance to one of two screens.</p> <p>If Bump Test In-field is enabled, the Bump Due Warning Option Screen displays.</p> <p>If the Bump Test In-field is disabled, the Alarm Latch Set Screen displays.</p>

Configuration Process	
Display and Options	Instructions
 <p>Bump Due Warning Option Screen Options 0 = Disable/off 1 = Enable/on</p>	<p>When enabled, the monitor will sound two beeps every 30 seconds and its display icons will indicate a bump test is due.</p> <p>Press ENTER to edit the value, if needed. Press ON/OFF/MODE to set the value and advance to the Bump Test Time Set-point Screen.</p>
 <p>Bump Test Time Set-point Screen Value range: .5 days to 7.0 days Value increment: .5 days</p>	<p>Sets the elapsed time allowed between bump tests.</p> <p>Press ENTER to edit the value, if needed; press repeatedly or hold down to speed the increment pace. Press ON/OFF/MODE to set the value and advance to the Bump Test Percentage Requirement Screen.</p>
 <p>Bump Test Percentage Requirement Screen Value range: 50% to 99% Value increment: one percent</p>	<p>Sets the percentage of calibration gas the monitor expects to be exposed to.</p> <p>Press ENTER to edit the value, if needed; press repeatedly or hold down to speed the increment pace. Press ON/OFF/MODE to set the value and advance to the Bump Test Response Time Screen.</p>
 <p>Bump Test Response Time Screen Value range: 30 to 300 seconds Value increment: five seconds</p>	<p>Sets the bump test response time period.</p> <p>Press ENTER to edit the value, if needed; press repeatedly or hold down to speed the increment pace. Press ON/OFF/MODE to set the value and advance to the Latch Alarm Set Screen.</p>
 <p>Latch Alarm Set Screen Options 0 = Normal mode 1 = Latching mode</p>	<p>When enabled, if the monitor goes into any gas-related alarm, it will remain in alarm until after the gas concentration is less than (or more than for oxygen) the alarm set point, and the monitor user presses the ENTER button for one second.</p> <p>Press ENTER to edit the value, if needed. Press ON/OFF/MODE to set the value and advance to the Zero In-field Screen.</p>

Configuration Process	
Display and Options	Instructions
 <p>Zero In-field Screen Options 0 = Disable/off 1 = Enable/on</p>	<p>When enabled, all monitor users are permitted to zero the monitor from the gas monitoring mode.</p> <p>Press ENTER to edit the value, if needed. Press ON/OFF/MODE to set the value and advance to one of two screens.</p> <p>If Zero In-field is enabled, the Calibration In-field Option screen displays. If Zero In-field is disabled, the Calibration Due Alarm screen displays.</p>
 <p>Calibration In-field Option Screen Options 0 = Disable/off 1 = Enable/on</p>	<p>When enabled, all monitor users are permitted to calibrate the monitor from the gas monitoring mode.</p> <p>Press ENTER to edit the value, if needed. Press ON/OFF/MODE to set the value and advance to the Calibration Due Alarm Option.</p>
 <p>Calibration Due Alarm Option Screen Options 0 = Disable/off 1 = Enable/on</p>	<p>When enabled, the monitor will activate the calibration due alarm, in gas monitoring mode, when any sensor is due for calibration. A flashing gas cylinder and gas type will appear on the display and three beeps will sound every 30 seconds.</p> <p>Press ENTER to edit the value, if needed. Press ON/OFF/MODE to set the value and advance to the Calibration Due Set-point screen.</p>
 <p>Calibration Due Set-point Screen Value range: one to 365 days Value increment: one day</p>	<p>Sets the elapsed time allowed between calibrations.</p> <p>Press ENTER to edit the value, if needed. Press ON/OFF/MODE to set the value and advance to the Calibration Days Set Screen.</p>
 <p>Calibration Days Set Screen Options 0 = display days since <i>last</i> calibration 1 = display days until <i>next</i> calibration</p>	<p>Sets how the Calibration Days Screen will display in operation mode.</p> <p>NOTE: The up arrow (▲) will be featured on-screen when the unit is set to display the number of days before a sensor's <i>next</i> calibration is due. The down arrow (▼) will be featured when the unit is set to display the number of days since the <i>last</i> calibration was performed. A value will be displayed for each installed sensor.</p> <p>Press ENTER to edit the value, if needed. Press ON/OFF/MODE to set the value and advance to the Security Code Set Screen</p>

Configuration Process	
Display and Options	Instructions
 <p>Security Code Set Screen Valid values: 000 to 999. Increment value: one</p>	<p>A security code value of 000 permits all monitor users to enter configuration mode and gain access to change the monitor's settings. A value other than 000 will restrict access to the configuration mode; it will also restrict access to the shutdown process for an instrument that is configured for "always on".</p> <p>Press ENTER to edit the value, if needed; press repeatedly or hold down to speed the increment pace.</p> <p>Press ON/OFF/MODE to set the value and advance to the Language Selection Screen.</p>
 <p>Language Selection Screen Options E = English F = French d = German</p>	<p>Allows the choice of display languages as applied to select screens.</p> <p>Press ENTER to edit the value, if needed.</p> <p>Press ON/OFF/MODE to set the value and return to the LEL Type Set Screen.</p>
 <p>Always-on Set Screen Options 0 = Disable/off 1 = Enable/on</p>	<p>When enabled, the shutdown process is security-code protected only if the security code is not equal to 000. If the code is set to anything other than 000, the user will be prompted to enter the unit's security code to complete the shutdown process.</p> <p>Press ENTER to edit the value, if needed.</p> <p>Press ON/OFF/MODE to set the value and advance to the next configuration mode screen.</p>
 <p>Shutdown In Alarm Screen Options 0 = Disallows shutdown 1 = Allows shutdown</p>	<p>Disallow or allow operator-activated shutdown when the unit is in alarm.</p> <p>Press ENTER to edit the value, if needed.</p> <p>Press ON/OFF/MODE to set the value and advance to the next configuration mode screen.</p>
 <p>Alarm on Dock Screen Options 0 = Disable/off</p>	<p>Disable or enable alarm indicators when the unit is docked.</p> <p>Press ENTER to edit the value, if needed.</p> <p>Press ON/OFF/MODE to set the value and advance to the next configuration mode screen.</p>

Configuration Process	
Display and Options	Instructions
1 = Enable/on	

► Monitor Use and Service

Proper monitor use and service includes everything from bump testing and calibration to keeping the monitor clean, proper air sampling, and the replacement of parts and components. Beginning with calibration and bump testing, the following sections provide information and instruction on all use and service tasks.

Zero, Calibration, and, Bump testing

Gas detection instruments are potentially life-saving devices. When completed regularly, the procedures defined below help to maintain proper instrument functionality and enhance operator safety.

Procedures

Configuration. The configuration process allows qualified personnel to review and adjust a unit's settings.

Bump Test (or "functional test"). Bump testing checks for sensor and alarm functionality. The installed sensors are briefly exposed to expected concentrations of calibration gases that are greater than the sensors' low alarm set points. When one or more sensors "pass" the test, they are "functional" and the unit will alarm. Each sensor's "pass" or "fail" result is indicated on the unit's display.

Note: a bump test does not measure for sensor *accuracy* (see "Calibration").

Zero. Zeroing sets each installed sensor to recognize the ambient air as clean air. If the ambient air is not truly clean air, any gasses that are present and relevant to the installed sensor types will be measured and displayed as zero. Readings will be inaccurate until the unit is correctly zeroed in truly fresh air or with a zero air cylinder.

Calibration. All sensors gradually degrade over time. This diminishes a sensor's ability to measure gas concentrations accurately; however, regular calibrations adjust the instrument to compensate for this decline in sensitivity. During calibration, the installed sensors are exposed to expected concentrations of calibration gases and, when needed, the instrument will self-adjust to ensure the accurate measurement and display of gas concentration values.

Note: When a sensor has degraded beyond an acceptable level, no further adjustment is possible and the sensor will no longer pass calibration.

Peak Readings. The instrument stores the highest detected gas readings, the "peak readings" or "peaks". Bump testing and calibration will often register new peak readings. Therefore, the clearing of the peak readings should *follow* each calibration. The instrument operator may also wish to clear the peak readings after a bump test, before a change in location, or after an alarm is addressed and cleared.

Note: The peak readings and the data log readings are stored independently of one another; therefore, clearing the peak reading does not affect the data log. Powering the instrument off or changing its battery does not affect the peak reading. These checks and balances help promote operator safety, and serve to contain the peak readings in a "black-box" manner. In the event of a gas-related incident, this black-box record can be useful to the safety team or a prospective investigator.

Recommendations

Industrial Scientific Corporation (ISC) minimum frequency recommendations for each procedure are summarized in the table below. These recommendations are based on field data, safe work procedures, industry best practices, and regulatory standards to help ensure worker safety. Industrial Scientific is not responsible for setting safety practices and policies. These policies may be affected by the directives and recommendations of regulatory groups, environmental conditions, operating conditions, instrument use patterns and exposure to gas, and other factors.

Procedure	ISC Recommended minimum frequency
Configuration	Before first use and as needed thereafter.
Calibration ^a	Before first use and monthly thereafter.
Bump test ^b	Prior to each day's use.

^aBetween regular calibrations, ISC also recommends a calibration be performed immediately following each of these incidences: the unit falls, is dropped, or experiences another significant impact; is exposed to water; fails a bump test; or has been repeatedly

exposed to an over-range (positive or negative) gas concentration. A calibration is also recommended after the installation of a new (or replacement) sensor.

^bIf conditions do not permit daily testing, bump tests may be done less frequently based on company safety policy.

Note: The use of calibration gases not provided by ISC may void product warranties and limit potential liability claims.

General information

The zero, calibration, and bump testing tasks are in-field *enabled* or in-field *disabled* in the configuration process. This permits or denies access to these functions from the gas monitoring mode. When any of these options is enabled, it is accessible to *all* monitor users. In gas monitoring mode, a series of presses on the ON/OFF/MODE button gives the user access to the following screens and processes in the order shown.

- Gas Monitoring Screen
- Days Since Calibration
- Zero Initiate (if in-field enabled)
 - Calibration Apply Gas Screen (if in-field enabled)
- Bump Test Initiate (if in-field enabled)
- Peak Readings
- TWA Readings
- STEL Readings

The monitor is capable of performing two types of calibration, and this option is set in configuration mode. The calibration type selected also determines the monitor's bump test type. With a "quick" calibration, the monitor is set to calibrate and bump test all installed sensors simultaneously. With a "standard" calibration setting, these tasks are completed independently for each installed sensor in the order shown below.

1. Oxygen sensor*
2. Toxic sensor 1
3. LEL sensor
4. Toxic sensor 2

*If set to the default value of 20.9% or 21%, the Oxygen sensor calibrates during the zero process and toxic 1 is the first to calibrate in the calibration process.

The Ventis MX4 monitor can be calibrated with any of the accessories listed.

- Calibration cup and/or tubing shipped with the monitor (see instructions below)
- V-Cal Calibration Station (consult the calibration station manual for instruction)
- DSX™ Docking Station for Ventis MX4 (consult the docking station manual for instruction)

Instructions

Calibration and Bump Testing with Calibration Cup and/or Tubing

Read all instructions before beginning: notices, supply check-list, gas cylinder preparation, and the complete screen-by-screen walk-through of the zero, calibrate, and bump test processes. Each process is presented in the order in which it is accessible from gas monitoring mode.

NOTICES

- *Industrial Scientific recommends that full monitor calibration be performed, using a known certified concentration(s) of Industrial Scientific calibration gas(es), to prepare the monitor for first time use, and monthly (at a minimum) thereafter, to help ensure monitor accuracy.*
- *Industrial Scientific also recommends that each monitor be zeroed and bump tested before each use with a known certified concentration(s) of Industrial Scientific calibration gas(es).*
- *Read ALL requirements and instructions outlined below, including the screen-by-screen process description, before beginning the zero, calibration, or bump testing processes.*
- *Only qualified personnel should zero, calibrate, or bump test a monitor.*
- *Zero, calibration, and bump testing functions should be performed in a fresh air environment known to be nonhazardous.*
- *After calibration or bump testing, or after terminating either process, **stop the flow of gas.***

Supplies

Item	Monitor/Regulator**		
	Aspirated monitor with Demand Flow Regulator**	Aspirated monitor with Positive Flow Regulator**	Diffusion monitor with Positive Flow Regulator**
Calibration cup*	No	No	Yes
Calibration tubing 2 feet in length*	Yes	No	Yes
Calibration tubing 2 feet in length with integrated "t" fitting	No	Yes	No
Calibration gas cylinder	Yes	Yes	Yes

*Shipped with monitor.

**Industrial Scientific recommends 1) the use of positive flow regulators with a flow rate of .5 LPM, and 2) the diffusion monitor be calibrated or bump tested using a positive flow regulator, *NOT* a demand flow regulator.



Diffusion monitor with positive flow regulator.



Aspirated monitor with demand flow regulator.

Prepare the gas cylinder for use

- According to the supply chart above, attach the correct regulator to the gas cylinder and turn clockwise to tighten.
- Next, choose instruction A., B., or C. based on the monitor/regulator combination in use.

A. Aspirated with demand flow regulator

Attach either end of the tubing to the cylinder's nipple.

DO NOT ATTACH THE OTHER END OF THE TUBING TO THE MONITOR BEFORE REACHING THE "APPLY GAS SCREEN". Completing the connection of the tubing will cause gas to flow. If gas is applied before reaching the appropriate screen, the monitor will go into alarm and a failure will be logged.

B. Aspirated with positive flow regulator

The calibration tubing with the t-fitting (not included) has two different sized openings, a narrow opening at one end and a wider opening at the other end.

Attach the wider opening to the nipple on the cylinder's regulator.



Attach the smaller opening to the pump inlet.

DO NOT APPLY THE GAS BEFORE REACHING THE "APPLY GAS SCREEN". If gas is applied before that point, the monitor will go into alarm and a failure will be logged.

- C. *Diffusion with positive flow regulator*
 Attach either end of the tubing to the cylinder's nipple.
 Attach the other end of the tubing to the calibration cup's nipple.

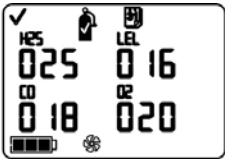
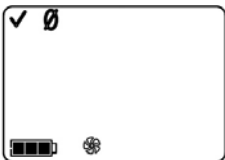

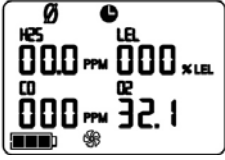
DO NOT ATTACH THE CALIBRATION CUP TO THE MONITOR OR APPLY THE GAS BEFORE REACHING THE "APPLY GAS SCREEN". If gas is applied before that point, the monitor will go into alarm and a failure will be logged.

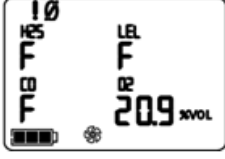

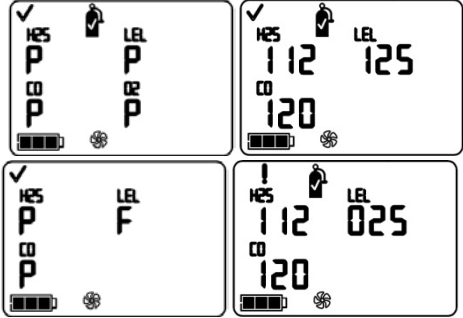
Zero and Quick Calibration Process	
Display and Options	Instructions
 <p>Gas Monitoring Screen Numeric mode display (left) Text mode display (right) Displays the gas concentration readings (or gas names in text mode) for all installed sensors. If a sensor is NOT installed, its position on the LCD is blank.</p>	<p>Press ON/OFF/MODE to advance to the Days since Calibration Screen.</p>
 <p>Days Since Calibration Screen Displays the number of days since the last successful calibration for each installed sensor. Each value can be different.</p>	<p>Press ON/OFF/MODE to advance to one of three screens.</p> <p>If zero in-field is enabled, the user advances to the Zero Initiate Screen.</p> <p>If zero in-field is disabled and bump test in-field is enabled, the user advances to the Bump Test Initiate Screen.</p> <p>If zero in-field and bump test in-field are both disabled, the user advances to the Peak Readings Screen.</p>
<p><i>NOTE: When zero, calibration, and bump test are ALL in-field enabled, and the user has entered zero from the gas monitoring mode, the monitor expects to be calibrated following a successful zero.</i></p> <p><i>If the desired task, after zero, is bump testing (or clearing the peaks) and NOT calibration, follow the instructions at the Calibration Apply Gas Screen to terminate calibration.</i></p>	
 <p>Zero Initiate Screen Options: Enter Zero Bypass Zero</p>	<p>Press ENTER to begin the zero process and advance to the Zero In-process Screen.</p> <p>Press ON/OFF/MODE to bypass zero and calibration and advance to one of two screens.</p> <p>If bump test in-field is <i>enabled</i>, the user advances to the Bump Test Initiate Screen.</p> <p>If bump test in-field is <i>disabled</i>, the user advances to the Peak Readings Screen.</p>



Zero and Quick Calibration Process	
Display and Options	Instructions
 <p>Zero In-process Screen</p> <p>Each sensor's numerical value becomes zero except O₂. An updated O₂ span value displays. The clock icon flashes and the zero icon displays.</p> <p><i>NOTE: The "span reserve" of a sensor measures its sensitivity. The displayed span value divided by the calibration gas value equals the span reserve percentage. A span reserve percentage of greater than 70% indicates a "good" sensor; 50%-70% indicates "marginal" sensitivity. When the span reserve percentage is less than 50%, the sensor will not pass calibration.</i></p>	<p>Allow the zero process to complete and advance to the Zero Results (Pass or Fail) Screen.</p> <p>After the zero process, press ON/OFF/MODE to bypass calibration of the installed toxic and combustible sensors. The user returns to the mode from which the calibration process was entered (configuration or gas monitoring).</p> <p><i>NOTE: during the zero process, the O₂ sensor is calibrated (when set to default gas volume of 20.9%)</i></p>
 <p>Zero Results (Pass) Screen</p> <p>The check mark displays to indicate a successful zero and a short beep sounds. Each sensor's numerical values display at zero except O₂.</p> <p>Options: Repeat zero Begin calibration Enter gas monitoring mode</p>	<p>Within Ten Seconds</p> <p>Press ENTER to repeat the zero process. Press ON/OFF/MODE to advance to one of two screens.</p> <p>If zero was entered from...</p> <p>...configuration mode, the user advances to the Calibration Apply Gas Screen.</p> <p>... gas monitoring mode and the calibration in-field option is <i>enabled</i>, the user advances to the Calibration Apply Gas Screen.</p> <p>...gas monitoring mode and the calibration in-field option is <i>disabled</i>, the user advances to the Gas Monitoring Screen in the gas monitoring mode.</p> <p>If neither ENTER nor ON/OFF/MODE is pressed, within ten seconds, the user advances to the Gas Monitoring Screen in the gas monitoring mode.</p>
 <p>Zero Results (Fail) Screen</p> <p>Displays an "F" or "P", respectively, for each failed or passed sensor. For O₂, if the sensor passed its calibration, the sensor reading displays.</p>	<p>Press ON/OFF/MODE (or wait ten seconds) to return to the Zero Initiate Screen and repeat the zero process.</p>

Zero and Quick Calibration Process	
Display and Options	Instructions
 <p>Calibration Apply Gas Screen*</p> <p>The gas cylinder icon flashes. Each sensor's display shows the calibration gas concentration to be applied. (The O₂ display is blank as the sensor was calibrated during zeroing.) The monitor waits up to five minutes to successfully sense the gas.</p> <p>Calibration In-progress Screen*</p> <p>If gas is sensed, the gas values for the LEL and toxic sensors increase and the O₂ value decreases.</p> <p>If gas is NOT sensed, a failed calibration registers and the Calibration Failed Screen displays.</p>	<p>To Terminate</p> <p>Press ON/OFF/MODE while the gas cylinder icon flashes to terminate the quick calibration process (or to skip a sensor's calibration in standard calibration) and return to the gas monitoring mode.</p> <p>To Calibrate</p> <p>From the already prepared gas cylinder, start the flow of gas as noted below for the monitor/regulator combination in use.</p> <p>For an aspirated monitor with a demand flow regulator, complete the tubing connection from the regulator to the pump inlet.</p> <p>For an aspirated monitor with a positive flow regulator, turn (counterclockwise) the regulator's knob.</p> <p>For a diffusion monitor with a positive flow regulator:</p> <ul style="list-style-type: none"> • Place the calibration cup over the upper portion of the monitor's case top (front of monitor). To attach properly, complete or observe the following. <ul style="list-style-type: none"> ○ The cup fully covers the sensor ports. ○ The monitor's display and buttons are NOT covered. ○ The cup's side arms fit securely in the grooves on the sides of the monitor. ○ The Ventis name on the calibration cup is upright and readable. ○ The cup's nipple points up and away from the monitor. • Turn (counterclockwise) the regulator's knob.
 <p>Sensor Results Screen*</p> <p>Pass (top) or Fail (bottom) Screen</p> <p>The display alternately shows a "P" for pass (or "F" for fail) and the final span value reading for each sensor. A check mark displays and a single beep sounds.</p> <p><i>NOTE: The "span reserve" of a sensor measures its sensitivity. The displayed span value divided by the calibration gas value equals the span reserve percentage. A span reserve percentage of greater than 70% indicates a "good" sensor; 50%-70% indicates "marginal" sensitivity. When the span reserve percentage is less than 50%, the sensor will not pass calibration.</i></p>	<p>STOP THE FLOW OF GAS.</p> <p>After calibration, or if calibration is terminated at any time during the process, stop the flow of gas as follows.</p> <p>For an aspirated monitor with a demand flow regulator, disconnect the tubing from the pump inlet.</p> <p>For an aspirated or diffusion monitor with a positive flow regulator, turn (clockwise) the regulator's knob.</p> <p>All Sensors Pass</p> <p>The user returns to the mode from which the calibration process was entered (configuration or gas monitoring).</p> <p>Sensor Fail</p> <p>If one or more sensors fail calibration, the Calibration Fail Screen displays and a system level alarm turns on.</p>

Zero and Quick Calibration Process	
Display and Options	Instructions
 <p>Calibration Failed Screen* Gas readings display for all successfully calibrated sensors and an “F” displays for any failed sensors. A system level alarm turns on. The warning icon and gas cylinder display to indicate a sensor calibration failure.</p>	<p>Any failed sensor stays in alarm until it passes a calibration or is replaced.</p> <p>Press ON/OFF/MODE to repeat calibration.</p>
<p>* During the standard calibration or standard bump test process, a series of apply gas, in-progress, and results screens show for EACH sensor as it is calibrated or tested.</p>	

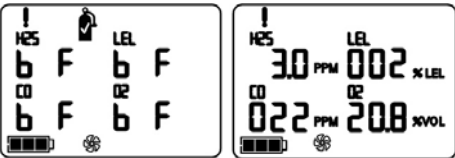
Bump Test Process	
Display and Options	Instructions
 <p>Bump Test Initiate Screen Options Begin process Bypass process</p>	<p>Press ON/OFF/MODE to bypass the bump test process and advance to the Peak Readings Screen. Press ENTER to begin the bump test process.</p>
 <p>Bump Test Apply Gas Screen Displays the bump test gas concentrations the monitor is expecting to receive. The monitor waits up to five minutes to successfully sense the gas.</p> <p>If gas is sensed, the user advances to the Bump Test In-progress Screen.</p> <p>If gas is NOT sensed, a failed bump test occurs and the user advances to the Bump Test Results Screen displays.</p>	<p>To Terminate Press ON/OFF/MODE while the gas cylinder icon flashes to terminate the quick bump test process (or to skip a sensor’s testing in standard bump testing). The user returns to the Gas Monitoring Screen.</p> <p>To Bump Test From the already prepared gas cylinder, start the flow of gas as noted below for the monitor/regulator combination in use.</p> <p>For an aspirated monitor with a demand flow regulator, complete the tubing connection from the regulator to the pump inlet.</p> <p>For an aspirated monitor with a positive flow regulator, turn (counterclockwise) the regulator’s knob.</p> <p>For a diffusion monitor with a positive flow regulator:</p> <ul style="list-style-type: none"> Place the calibration cup over the upper portion of the monitor’s case top (front of monitor). To attach properly, complete or observe the following.

Bump Test Process	
Display and Options	Instructions
	<ul style="list-style-type: none"> ○ The cup fully covers the sensor ports. ○ The monitor's display and buttons are not covered. ○ The cup's side arms fit securely in the grooves on the sides of the monitor. ○ The Ventis name on the calibration cup is upright and readable. ○ The cup's nipple points up and away from the monitor. ● Turn (counterclockwise) the regulator's knob.
 <p>Bump Test In-progress Screen Displays when gas is sensed within five minutes. The clock icon flashes to indicate the test is in-progress. The sensor reading(s) display. The LEL and toxic sensor readings increase and the O₂ reading decreases.</p>	<p>As the bump test progresses, observe the display activity (left).</p> <p>After the bump test, the Bump Test Results Screen displays.</p> <p>STOP THE FLOW OF GAS. After bump testing, or if bump testing is terminated at any time during the process, stop the flow of gas from the cylinder as follows.</p> <p>For an aspirated monitor with a demand flow regulator, disconnect the tubing from the pump inlet.</p> <p>For an aspirated or diffusion monitor with a positive flow regulator, turn (clockwise) the regulator's knob.</p>
 <p>Bump Test Results (Pass) Screen The above displays an all sensor pass result. If one or more sensors fail, the "F" shows in place of the "P". The pass/fail screen (left) and the final sensor reading screen (right) display alternately three times. A single beep sounds to indicate the bump test is completed.</p>	<p>No User Action Required After a passed bump test, the monitor goes into gas monitoring mode.</p>
 <p>Bump Test Results (Fail) Screen The "bF" displays under each gas type to indicate a bump test failure. The system level alarm turns on and the gas cylinder icon flashes.</p>	<p>After a failed bump test, the Bump Test Fail Screen displays and a low level audio alarm turns on.</p> <p>The monitor should be fully calibrated after a failed bump test.</p> <p><i>NOTE: After a full calibration, the O₂ sensor must pass a bump test to clear the bump test fail status.</i></p>

Bump Test Process	
Display and Options	Instructions
 <p>Peak Readings Screen Displays the peak icon and peak gas concentrations for each installed sensor since the last time the peak readings were cleared. (For O₂, the lowest reading is shown.)</p>	<p>Press and release ENTER to clear the peak values, if desired. Press ON/OFF/MODE to advance to one of two screens.</p> <p>If toxic sensors are installed, the user advances to the TWA Readings Screen.</p> <p>If no toxic sensors are installed, the user advances to the Gas Monitoring Screen.</p>
 <p>TWA Readings Screen Displays the TWA (time weighted average) icon and calculated readings for each toxic sensor installed; all other sensor values are blank.</p>	<p>Press and release ENTER to clear the displayed TWA reading(s), if desired. Press ON/OFF/MODE to advance to the STEL Readings Screen.</p>
 <p>STEL Readings Screen Displays the STEL (short term exposure limit) icon and STEL values for each toxic sensor installed; all other sensor values are blank. The STEL value is the running average over the last 15 minutes.</p>	<p>Press and release ENTER to clear the reading(s), if desired. Press ON/OFF/MODE to advance to the Gas Monitoring Screen.</p>
* During the standard calibration process, a series of apply gas, in-progress, and results screens show for EACH sensor as it is calibrated or tested.	

Remote Sampling

Aspirated monitor

In confined space, an air sample should be taken in four foot (1.2192 m) intervals.

Guidelines for using a motorized pump and sampling line

When sampling with a motorized pump and sampling line, Industrial Scientific recommends the following:

- Choose the tubing type based on the target gases. If the target gases are *known*, use Teflon-lined tubing when sampling for these gases: chlorine (Cl₂), chlorine dioxide (ClO₂), hydrogen chloride (HCl), and volatile organic compounds (VOCs). For other *known* target gases, urethane tubing or Teflon-lined tubing may be used.
When the target gases are *unknown*, use Teflon-lined tubing.
- Know the length of the sample line as it is a factor in determining sampling time. A sample line may consist of tubing, a probe, or a probe and tubing. It should also have a dust filter–water stop installed at the line's end that will extend into the sample area. Sample-line length is defined as the distance from the dust filter–water stop

opening to the point where the line connects to the pump's inlet. Ensure sample-line length does not exceed the pump's maximum draw.

- Before and after each air sample, perform a test of the full sampling line.
 - Use a thumb to block the end of the sampling line at the water-stop opening. This should cause a pump-fault alarm.
 - Remove the thumb from the water-stop opening. After the alarm cycle completes, the pump should resume normal operation.

Note: If a pump fault does *not* occur, check and correct for cracks or other damage, debris, and proper installation in these areas: all sampling line connections, the pump's inlet cap and inlet barrel, and the dust filter-water stop items at the end of the sampling line and inside the pump inlet barrel.

- Based on sample-line length, calculate the *minimum time* recommended for the air sample to reach the instrument's sensors. As shown below, use a base time of 2 minutes, and add 2 seconds for each 30 cm (1 ') of line length. Watch the display screen for gas readings and, if present, allow them to stabilize to determine the reading.

Minimum sample time for common sample-line lengths

Sample-line length	Base time (minutes)	+	Sample-line-length factor (seconds)	=	Minimum sample time (mm:ss)
3.05 m (10')	2 min	+	(10 x 2 s)	=	02:20
6.10 m (20')	2 min	+	(20 x 2 s)	=	02:40
9.14 m (30')	2 min	+	(30 x 2 s)	=	03:00
12.10 m (40')	2 min	+	(40 x 2 s)	=	03:20
15.24 m (50')	2 min	+	(50 x 2 s)	=	03:40
18.29 m (60')	2 min	+	(60 x 2 s)	=	04:00
21.34 m (70')	2 min	+	(70 x 2 s)	=	04:20
24.38 m (80')	2 min	+	(80 x 2 s)	=	04:40
27.43 m (90')	2 min	+	(90 x 2 s)	=	05:00
30.48 m (100')	2 min	+	(100 x 2 s)	=	05:20

Cleaning

- NEVER use solvents or cleaning solutions of any type.
- When necessary, wipe the outside of the Ventis MX4 with a soft, clean cloth.
- Make sure the sensor diffusion membrane, inside and out, is free of debris; wipe gently with a cloth or brush that is soft, clean, and dry.
- Make sure the aspirated monitor's inlet is free of debris.

Service

Instructions are provided for battery service; monitor conversion; sensor, sensor barrier and LCD service; and pump assembly service. Refer to the three-dimensional view diagrams to identify the parts referenced in the instruction sets, and for screw torque values.

Read all instructions before beginning any monitor service.

NOTICES

- Before beginning any service tasks, power-off the monitor.
- Only qualified staff should perform monitor service and should take the following precautions.
 - Take care not to touch battery contacts on the monitor or the battery itself.
 - Perform work in a clean air environment that is known to be nonhazardous.
 - Perform work on a nonconductive work surface.
 - Wear grounding straps.

Alkaline battery setup



1. Unlatch and lift the hinged portion of the battery housing.
2. Place AAA battery types Energizer EN92 or Duracell MN2400 so the negative (-) end of the battery, touches the spring inside the battery housing. Do NOT mix battery types.
3. When all three AAA batteries are properly installed, close the battery housing. A “Click” will be heard when the latch catches securely.
4. When replacing batteries, dispose of spent batteries according to company policy.

Aspirated Monitor

The aspirated monitor can be used with two Ventis battery types.

- The Extended range Li-ion battery
- The Alkaline battery

⚠ Power off the instrument before disassembling it or performing any service task.

Pump with battery installation



Unscrew and remove the belt clip. Store the clip, screw, and washer for future use.



Unscrew, lift, and remove the battery from the diffusion instrument; store it for future use.



Loosen the pump door screw.



Slide the pump door down.



Lift door to open.



Install a compatible Extended range battery—label side up—into the lower receptacle of the pump case.



Place the instrument in the pump case; tighten* the four torx screws on the back of the pump.



Lower the pump door. Slide it into its fully closed, clicked-shut position.



Tighten* the pump door screw.

Pump door replacement



Loosen the pump door screw. Slide the pump door down; lift it to open.

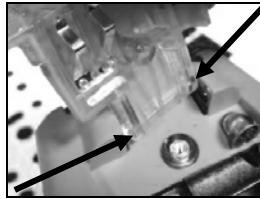

The door is hinged to the pump module with two pegs that slide into grooves. Angle the door so that one peg moves to the bottom of its groove and the other moves the top of its groove. Lift the door to remove it. Install the new door in the same manner the door was removed.



Lower the pump door. Slide it into its fully closed, clicked-shut position. Tighten* the pump door screw.

*Torque value is .39 Newton-meters (55 ounce-force inch)

Pump cap and water barrier replacement



To unscrew and remove the pump cap, turn it in a counterclockwise direction.



Remove the water barrier from the inlet barrel.



Place the new water barrier inside the inlet barrel; the side with the larger filter surface should face the user.





Secure the pump cap to the inlet barrel: turn it in a clockwise direction to tighten.

Diffusion Monitor

The diffusion monitor can be used with all four Ventis battery types:

- The Li-ion battery
- The Slim extended Li-ion battery
- The Extended range Li-ion battery
- The Alkaline battery

Battery installation

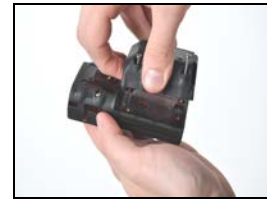

Using a torx screwdriver, loosen all four screws from the battery (left) or the battery cover (right).

Lift the battery (left) or battery cover and Extended range battery (right) away from the instrument.

Note: The Extended range battery will easily fit into the battery cover. If the battery does not easily insert, stop to ensure proper placement as noted in the instruction.



To install the Extended range battery, first place the battery in the battery cover. When placed correctly, the battery's label will show.

Next, align the battery cover with the instrument.

To install the battery, align it with the instrument.

Using a torx screwdriver, tighten* each of the four screws to secure the battery (shown) or battery cover to the instrument.

*Torque value is .39 Newton-meters (55 ounce-force inch).

Suspender clip

When worn, the diffusion monitor should be fastened securely and attached to ensure the sensor portals are exposed to the air. The monitor should be in full view. No part of the monitor should be covered by any garment or part of a garment.

Clip replacement

Clip only (use with battery and Slim extended battery)



Lift the clip's cover.



To remove the clip, use a Phillips screwdriver to access the clip's screw. Turn counterclockwise to loosen the screw.

Remove the screw, washer, and clip; set aside or store for future use.



To attach the clip, put the washer onto the screw and place the screw in the clip's middle hole.

Turn the screw clockwise to tighten*.

Clip with spacer (use with Extended battery and battery cover)



To remove the clip, use a Phillips screwdriver to access the clip's screw. Turn counterclockwise to loosen the screw.

Remove the washer, screw, clip, and spacer; set aside or store for future use.



To attach the clip and spacer, cover the case bottom's platform with the spacer.

Put the washer onto the screw and place the screw in the clip's middle hole.



Guide the screw into the spacer's hole and into the instrument case bottom.

Turn clockwise to tighten*.

*Torque value is .88 Newton-meters (125 ounce-force inch).

Sensor, Sensor Barrier, LCD, and vibrating motor replacement

Service instruction sets are provided below. Follow the instruction relevant to the desired task and take note of the following:

- The monitor has a two-part circuit board assembly, the main board and a smaller sensor board. They are attached to one another with a connector at the center of the sensor board.
- The sensor barrier can be replaced as an assembly that fits in the monitor's case top, or the full case top can be replaced. *NOTE: When a sensor is replaced, it is recommended that the sensor barrier/case top also be replaced. After reassembling the monitor, a full calibration should be completed.*
- The LCD is removed and attached as a single component.

Disassembling the Monitor. (For the Diffusion monitor start with Step 6.)	
1	Power-off the monitor.
2	Loosen the four captive screws on the lower portion of the pump case module bottom (back of the module).
3	Loosen the single captive screw on the pump case module top.
4	Loosen the front door screw; slide the case door down; lift the hinged door to reveal and access the monitor.
5	Lift and remove the monitor from the pump module; set aside the module.
6	Place the monitor display side down. For a diffusion monitor loosen the four captive battery screws to separate the battery from the case bottom.
7	Loosen the two captive screws on the upper portion of the case bottom.
8	Lift to separate the monitor case top from the monitor case bottom to reveal the circuit board assembly.
9	Remove the circuit board assembly and set aside the monitor case top and bottom.
10	Separate the main circuit board from the sensor board.
Replacing the LCD	
1	Grasp the sides of the LCD and lift straight up to remove from the main circuit board.
2	To properly place the new LCD, align the pins on the LCD with their receptacles on the main circuit board.
3	Gently press straight down and into place.
Replacing the Sensor(s)	
1	Identify the sensor to be removed.
2	Gently lift and remove the sensor.
3	To add the new sensor, align its pins or connector(s), with the respective receptacles on the sensor board.
4	Press down. A slight click indicates the sensor is securely in place.
Reassembling the Circuit Board Assembly	
1	Re-attach the main circuit board to the sensor board, aligning their connectors.
2	Press. A slight click indicates the boards are securely attached.
Replacing the Sensor Barrier or Case Top	
<i>To replace the sensor barrier on the inside of the case top, follow steps 1-5 below.</i>	
<i>To replace the entire case top, skip to the instruction set, "Reassembling the Monitor".</i>	
1	Observe the placement of the existing sensor barrier. Note that each cut-out is shaped to match the sensor it protects.
2	Lift and remove the sensor barrier and gasket from inside the monitor case top. Ensure the entire case top is free of adhesive; gently scrape, if needed. Wipe with a clean, dry, soft cloth or brush.
3	Lift the backing from the new sensor barrier assembly to reveal the adhesive.
4	Carefully position the new barrier. Each shaped opening matches the shape of the sensor it protects. Press to attach to the inside of the case top.
Replacing the Vibrating Motor	
1	Place the monitor's case top face down.
2	Lift the vibrating motor from its partition. The partition has two sections divided by a ridge. Discard the used motor.
3	To properly place the new vibrating motor, its contact pins face the user and align with the left edge of the partition. (The motor's movable component fits within the small section of the partition.)
4	Press into place.

Reassembling the Monitor	
1	Re-place the board assembly into the monitor's case bottom. The LCD faces the user.
2	Re-place the monitor's case top (or place its new case top).
3	Tighten* the two captive screws on the upper portion of the monitor case bottom.
4	Re-place the monitor inside the pump module. The monitor is display side up and its logo readable. Its lower exposed bottom portion covers the battery. For the diffusion monitor, re-place the battery or battery cover assembly.
5	Tighten* the four screws on the pump module bottom to secure the module to the monitor, or tighten* the four captive screws on the battery pack for a diffusion monitor.
6	Close the pump module door; slide up to click in place.
7	Tighten* the pump door screw to secure.
8	Dispose of the used sensor(s) according to company policy.
9	Perform a full calibration following the addition or replacement of any sensor, or the replacement of the sensor water barrier or monitor case top.

*Torque value is .39 Newton-meters (55 ounce-force inch).

Ventis MX4 Monitor three-Dimensional Diagram

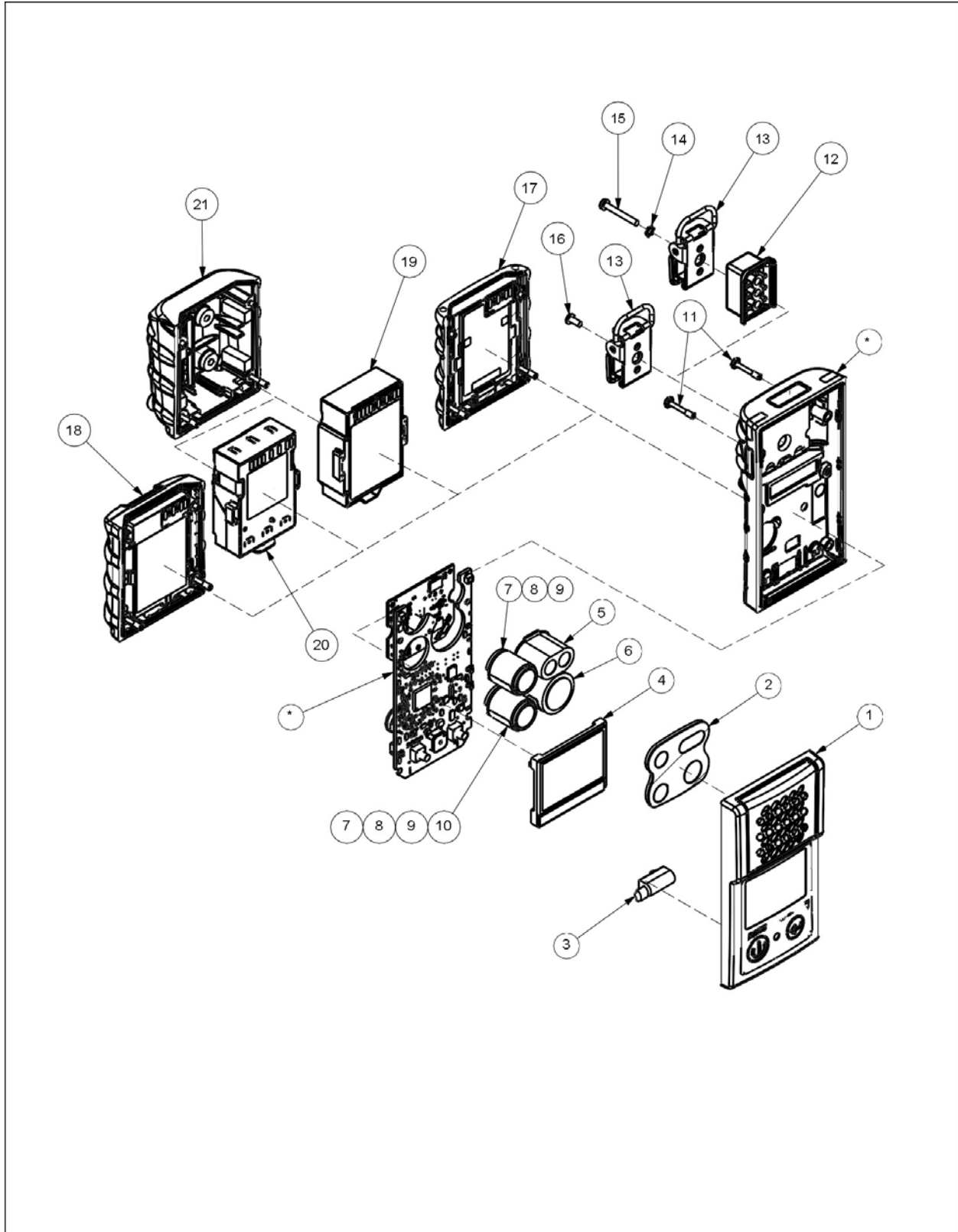

Key for Ventis MX4 Monitor three-Dimensional Diagram		
Number	Part Number (P/N)	Description
1	17152380-X	Ventis MX4 Diffusion Case Top Assembly (includes items 2 and 3) X = Case Color, where: 0 = Black, 1 = Orange
2	17152429	Sensor Barrier Assembly
3	17145285	Vibrating Motor
4	17150772	Ventis MX4 LCD Assembly
5	17134495	Ventis MX4 Sensor, Combustible Gas (LEL/CH ₄)
6	17134461	Ventis MX4 Sensor, Oxygen (O ₂)
7	17134487	Ventis MX4 Sensor, Carbon Monoxide (CO)
7	17155564	Ventis MX4 Sensor, Carbon Monoxide/Low Hydrogen Interference (CO/H ₂ Low)
8	17134479	Ventis MX4 Sensor, Hydrogen Sulfide (H ₂ S)
9	17134503	Ventis MX4 Sensor, Nitrogen Dioxide (NO ₂)
10	17143595	Ventis MX4 Sensor, Sulfur Dioxide (SO ₂)
11	17147281	Captive Case Screw, Torx (torque value: 55 oz-in or .39 N.m +/- 10%)
12	17152506**	Suspender Clip Spacer
13	17120528**	Suspender Clip
14	17153137**	Locking Washer
15	17152507**	Screw, Phillips (for use with items 12, 13 and 14) (torque value: 125 oz-in or .88 N.m +/- 10%)
16	17139262	Screw, Phillips (torque value: 125 oz-in or .88 N.m +/- 10%)
Batteries		
17	17134453-XY	Lithium-ion battery
18	17157350-XY	Slim extended lithium-ion battery
19	17148313-Y	Extended range lithium-ion battery
20	17150608-XY	Alkaline battery (CSA, China MA, and China KA approved for diffusion monitor only.)
21	17151184-XY**	Battery cover (for use with Extended range battery)
<p>See Battery part numbers and options for orderable part numbers.</p> <p>Screw Torque: 0.39 newton m (55 ounce-force inch)</p>		
<p>* Item in diagram is not user replaceable. The Ventis MX4 monitor must be sent to an authorized ISC Service Center for this item to be replaced.</p> <p>** Available in a conversion kit – VTSB-2XY (orderable part number); when converting an aspirated monitor to a diffusion monitor with a rechargeable Extended range Li-ion battery or Alkaline battery. (Batteries sold separately.)</p>		

Battery Configuration

The base part number that appears on the *label* of a Ventis battery item uses an eight-digit numeric format (XXXXXXXX). The corresponding *orderable* part numbers use the four-letter base reference "VTSB", which is followed by a three character suffix. The first suffix character is a number that designates the battery type; the second and third are used to indicate color and approval options, respectively. For example, as shown below in the *Battery part numbers and options*, a rechargeable Slim extended lithium-ion battery kit that is black and has a UL approval would have an orderable part number of VTSB-401 and its label would state a part number of 17157350-01.

Battery part numbers and options

Diagram number	Battery kit	Part numbers		Options ^a (X and Y)
		Label	Orderable kit	
17	Rechargeable Lithium-ion battery	17134453-XY	VTSB-1XY	X indicates color: 0 for black; 1 for orange
18	Rechargeable Slim extended lithium-ion battery	17157350-XY	VTSB-4XY	Y indicates approvals: 1 for UL, CSA, ATEX, IECEx, EAC (GOST-K and GOST-R); KOSHA, MED, SANS, and TIIS; 2 for MSHA; 3 for China EX; 4 for ANZEX; 5 for INMETRO; and C for China KA
19 and 21	Rechargeable Extended range lithium-ion battery kit (includes battery and cover)	17148313-Y ^c (battery) 17151184-XY (cover)	VTSB-2XY (kit) ^b	
20	Alkaline battery	17150608 ^c	VTSB-3XY	

^a Color and approval options may vary for each battery item. For more information, contact Industrial Scientific or an authorized distributor of its products.

^b The battery and cover may be ordered separately using these part numbers 17148313-Y (battery) 17151184-XY (cover).

^c Aspirated instruments only.

Ventis MX4 Pump module three-Dimensional Diagram

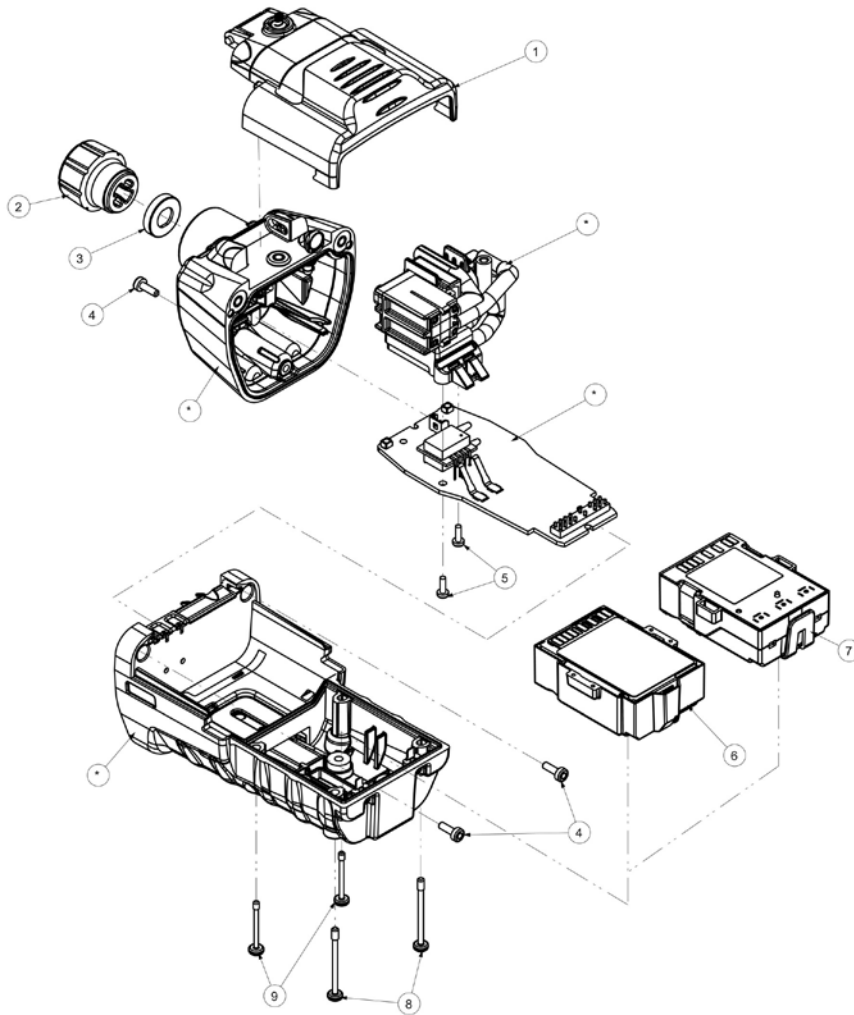

KEY FOR VENTIS MX4 PUMP MODULE THREE-DIMENSIONAL DIAGRAM		
Number	Part Number (P/N)	Description
1	17151150-X0	Ventis MX4 Pump Door Assembly X = Pump Door Assembly Color, where: 0 = Black, 1 = Orange (captive screw torque value: 55 oz. in. or .39 N.m +/- 10%)
2	17129909	Pump Inlet Filter Cap
2	17141581	Pump Inlet-Filter Cap for use 6' extendable probe
2	17141599	Filter Cap, 1/8 NPT Female
3	17152395	Water Barrier
4	17151275	Screw, Torx (torque value: 55 oz-in or .39 N.m +/- 10%)
5	17052558	Screw (torque value: 25 oz-in or .17 N.m +/- 10%)
6	17148313-Y	Extended Range Lithium-ion Battery Pack Y = Approval where: 1 = UL, CSA, ATEX, IECEX, INMETRO, GOST-R, GOST-K, KOSHA, and TIIS 2 = MSHA 3 = China Ex 4 = ANZEX

KEY FOR VENTIS MX4 PUMP MODULE THREE-DIMENSIONAL DIAGRAM		
Number	Part Number (P/N)	Description
7	17150608	Alkaline Battery: UL, ATEX, IECEx, ANZEx, and INMETRO approvals (CSA, China KA and China MA approved for diffusion monitor only.)
8	17151028	Captive Case Screw, TorX (torque value: 55 oz-in or .39 N.m +/- 10%)
9	17151036	Captive Case Screw, TorX (torque value: 55 oz-in or .39 N.m +/- 10%)
* Item is not user replaceable. The Ventis MX4 Pump Module must be sent to an authorized ISC Service Center for this item to be replaced.		

► Products, Specifications, and Certifications

Ventis MX4 Accessories and Parts

Sensors, Sensor Barrier, Vibrating Motor, LCD, and Calibration Cup	
17134495	Ventis MX4 Sensor, Combustible Gas (LEL/CH ₄)
17134461	Ventis MX4 Sensor, Oxygen (O ₂)
17134487	Ventis MX4 Sensor, Carbon Monoxide (CO)
17155564	Ventis MX4 Sensor, Carbon Monoxide/Low Hydrogen Interference (CO/H ₂ Low)
17134479	Ventis MX4 Sensor, Hydrogen Sulfide (H ₂ S)
17134503	Ventis MX4 Sensor, Nitrogen Dioxide (NO ₂)
17143595	Ventis MX4 Sensor, Sulfur Dioxide (SO ₂)
17152380-X	Diffusion Case Top Assembly (includes Sensor Barrier Assembly) X = Case Top Color, where: 0 = Black, 1 = Orange
17152429	Sensor Barrier Assembly
17145285	Vibrating Motor
17150772	Ventis MX4 LCD Assembly
17156189	Ventis Calibration Cup Assembly, calibration cup with tubing
17152455	Ventis Calibration Cup

Monitor Specifications

Item	Description		
Display	Backlit Liquid Crystal Display (LCD)		
Buttons	Two (ON/OFF/MODE and ENTER)		
Monitor case	Polycarbonate with ESD protective rubber overmold		
Alarms	Ultra-bright LEDs, loud audible alarm (95dB at 30 cm), and vibrating alarm		
Size and Weight	Diffusion with Lithium-ion (typical)	Diffusion with Slim extended Lithium-ion (typical)	Aspirated with Extended Range Lithium-ion (typical)
Size	103 mm x 58 mm x 30 mm (4.1" x 2.3" x 1.2")	103 mm x 58 mm x 36 mm (4.1" x 2.3" x 1.4")	172 mm x 67 mm x 66 mm (6.8" x 2.6" x 2.6")
Weight	182 g (6.4 oz)	207 g (7.3 oz)	380 g (13.4 oz)

Battery Specifications

The battery specifications table shown below, includes run time, charge time, charging temperature requirements, and expected lifetime.

Battery specifications table

	Rechargeable batteries (part number)			Replaceable batteries (part number)
	Lithium-ion battery	Slim extended lithium-ion battery	Extended range lithium-ion battery	Alkaline battery
	(VTSB-1XY [°])	(VTSB-4XY [°])	(VTSB-2XY [°])	(VTSB-3XY [°])
Run time ^a Diffusion	12 hours	18 hours	20 hours	8 hours
Run time ^a Aspirated	–	–	12 hours	4 hours
Charge time ^b	up to 5 hours	up to 7 hours	up to 7.5 hours	–
Ambient temperature required for charging	0 – 40 °C (32 – 104 °F)	0 – 40 °C (32 – 104 °F)	0 – 40 °C (32 – 104 °F)	–

^aApproximate run time when the battery is fully charged, and operating at room temperature.

^bWhen a lithium-ion battery becomes deeply discharged and the instrument is docked, it can take up to an hour for the instrument display to indicate that the battery is charging.

[°]X indicates color and Y indicates approvals.

Note: Batteries can withstand 300 charge cycles over their lifetime.

Operating Conditions

Warm-up time	40 seconds (includes stabilization time)
Temperature range	-20 °C to +50 °C (-4 °F to +122 °F)
Humidity range	15–95% relative humidity (RH) noncondensing (during continuous operation)
Pressure range	1 atm ±20%

Cold-weather Operation

Use caution when operating the instrument in temperatures below -20 °C (-4 °F), which can diminish display-screen legibility. To help support functionality and available battery power, the following practices are recommended.

- Do not operate the instrument in temperatures that are not within the temperature ranges of the installed sensors (see "Sensor specifications").
- Use a compatible, fully charged lithium-ion battery.
- Before using the instrument in the cold-weather environment, power it on a warm-up environment (approximately 20 °C [68 °F]).
- Alternately operate the instrument in the cold-weather and warm-up environments.
- Do not operate the instrument unmanned.

Storage Conditions

Temperature range	0–25 °C (32–77 °F)
Humidity range	40–70% relative humidity (RH) noncondensing
Pressure range	0.9–1.1 atm
Maximum time	Up to 6 months Note: Industrial Scientific recommends that infrequently used lithium-ion batteries be fully charged every four months.

Sensor Specifications

Gas Name	Abbr.	Measuring Range	Resolution	Accuracy at Time and Temperature of Calibration*	Response Time (typical) T50	Response Time (typical) T90
Oxygen	O ₂	0–30% vol	0.1% vol	± 0.5%	15	30
Carbon Monoxide with low H ₂ interference	CO/H ₂ Low	0–1000 ppm	1 ppm	± 5% (0-300 ppm) ± 15% (301-1000 ppm)	8	17
Carbon Monoxide	CO	0–1000 ppm	1 ppm	± 5%	15	50
Hydrogen Sulfide	H ₂ S	0–500 ppm	0.1 ppm	± 5%	15	30
Nitrogen Dioxide	NO ₂	0–150 ppm	0.1 ppm	± 10%	10	30
Sulfur Dioxide	SO ₂	0–150 ppm	0.1 ppm	± 10%	20	80
Combustible	LEL	0–100% LEL	1% LEL	± 5%	15	35
Methane	CH ₄	0–5% vol	0.01% vol	± 5%	15	35

*The accuracy specification for each sensor is ± the stated percentage or 1 unit of resolution, whichever is greater.

Toxic Gas Sensor Cross-sensitivity Table

Target Gas	Sensor												
	CO	CO (H ₂ Low)	H ₂ S	SO ₂	NO ₂	Cl ₂	ClO ₂	HCN	HCl	PH ₃	NO	H ₂	NH ₃
CO	100	100	1	1	0	0	0	0	0	0	0	20	0
H ₂ S	5	5	100	1	-40	-3	-25	10	300	25	10	20	25
SO ₂	0	5	5	100	0	0	0	—	40	—	0	0	-40
NO ₂	-5	5	-25	-165	100	45	—	-70	—	—	30	0	-10
Cl ₂	-10	0	-20	-25	10	100	60	-20	6	-20	0	0	-50
ClO ₂	—	—	—	—	—	20	100	—	—	—	—	—	—
HCN	15	—	10	50	1	0	0	100	35	1	0	30	5
HCl	3	—	0	5	0	2	0	0	100	0	15	0	0
PH ₃	—	—	—	—	—	—	-100	425	300	100	—	—	—
NO	25	40	1	1	5	—	—	-5	—	—	100	30	0
H ₂	22	3	0.1	0.5	0	0	0	0	0	0	0	100	0
NH ₃	0	0	0	0	0	0	0	0	0	0	0	0	100

The Sensor Cross Sensitivity Table (above) reflects the percentage response provided by the sensor (top row) when exposed to a known concentration of the target gas (column 1).

The numbers were measured under these environmental conditions: 20 °C (68 °F) , 50% RH and 1 atm.

The specified cross-interference numbers apply to new sensors only, and may vary with time as well as from sensor to sensor.

“—” means no data available.

This table is given as a reference only and is subject to change.

LEL, and LEL Correlation Factors for Combustible Gases

Sample gas*	LEL (% vol)	LEL correlation factors					
		Calibration gas					
		Butane	Hexane	Hydrogen	Methane	Pentane	Propane
Acetone	2.5%	1.00	0.70	1.70	1.70	0.90	1.10
Acetylene	2.5%	0.70	0.60	1.30	1.30	0.70	0.80
Benzene	1.2%	1.10	0.80	1.90	1.90	1.00	1.20
Butane	1.9%	1.00	0.58	1.78	1.67	0.83	1.03
Ethane	3.0%	0.80	0.60	1.30	1.30	0.70	0.80
Ethanol	3.3%	0.89	0.52	1.59	1.49	0.74	0.92
Ethylene	2.7%	0.80	0.60	1.40	1.30	0.70	0.90
Hexane	1.1%	1.71	1.00	3.04	2.86	1.42	1.77
Hydrogen	4.0%	0.56	0.33	1.00	0.94	0.47	0.58
Isopropanol	2.0%	1.10	0.90	2.00	1.90	1.00	1.20
Methane	5.0%	0.60	0.35	1.06	1.00	0.50	0.62
Methanol	6.0%	0.60	0.50	1.10	1.10	0.60	0.70
Nonane	0.8%	2.22	1.30	3.95	3.71	1.84	2.29
Pentane	1.4%	1.21	0.71	2.15	2.02	1.00	1.25
Propane	2.1%	0.97	0.57	1.72	1.62	0.80	1.00
Styrene	0.9%	1.30	1.00	2.20	2.20	1.10	1.40
Toluene	1.1%	1.53	0.89	2.71	2.55	1.26	1.57
Xylene	1.1%	1.50	1.10	2.60	2.50	1.30	1.60
JP-4	—	—	—	—	—	1.20	—
JP-5	—	—	—	—	—	0.90	—
JP-8	—	—	—	—	—	1.50	—

NOTE: The table above provides the LEL for select combustible gases*. It also provides correlation factors that help the safety technician and instrument operator determine the actual percentage LEL when the sample gas differs from the gas that was used to calibrate the unit.

For example, if the unit reads 10% LEL in a *pentane* atmosphere, and was calibrated to *methane*, the actual percentage LEL is determined as follows:

1. Locate the table cell where the sample gas (pentane) intersects with the calibration gas (methane).
2. Multiply the cell's value (2.02) by the unit's LEL reading (10%) to calculate the actual concentration of 20.2% LEL.

* The combustible gas list is not a comprehensive list of all combustible gases that can be detected by the Ventis MX4. For additional information about combustible gas detection and the Ventis MX4, contact the ISC Technical Service department.

Certifications

Certifications for the **Ventis™ MX4 Multi-Gas Monitor**, at the time of this document's publication, are listed below in the *Hazardous-area certifications table*. To determine the hazardous-area classifications for which an instrument is certified, refer to its label or the instrument order.

Hazardous-area certifications table

Certifying Body (CB)	Area Classifications	Approved Temperature Range
ANZEx	Ex ia s Zone 0 I/IIC, Temperature Class T4	-20 °C to +50 °C (-4 °F to +122 °F)
ATEX ^a	Ex ia IIC, equipment protection level Ga, Temperature Class T4; Ex ia I, equipment protection level Ma; Equipment Group and Category II 1G and I M1	-20 °C to +50 °C (-4 °F to +122 °F)
China Ex	Ex ia IIC, equipment protection level Ga, Temperature Class T4; Ex ia d I Mb	-20 °C to +50 °C (-4 °F to +122 °F)
China CMC	Metrology approval	-20 °C to +50 °C (-4 °F to +122 °F)
China MA	Approved with underground mines with CO, H2S, O2 and CH4 (Diffusion with 17134453 battery only.)	-20 °C to +50 °C (-4 °F to +122 °F)
CSA	Class I, Groups A, B, C, and D, Temperature Class T4 Ex d ia IIC, Temperature Class T4	-20 °C to +50 °C (-4 °F to +122 °F)
GOST EAC	PBExiadl X / 1ExiadlICT4 X GOST-R Metrology approval, GOST-K Metrology	-20 °C to +50 °C (-4 °F to +122 °F)
IECEX ^a	Ex ia IIC, equipment protection level Ga, Temperature Class T4	-20 °C to +50 °C (-4 °F to +122 °F)
INMETRO	Ex ia IIC, equipment protection level Ga, Temperature Class T4	-20 °C to +50 °C (-4 °F to +122 °F)
KOSHA	Ex d ia IIC, Temperature Class T4	-20 °C to +50 °C (-4 °F to +122 °F)
MASC	SANS 1515-1; Type A; Ex ia I/IIC, Temperature Class T4	-20 °C to +50 °C (-4 °F to +122 °F)
MED	MED 2014/90/EU Marine Directive	-20 °C to +50 °C (-4 °F to +122 °F)
MSHA ^b	30 CFR Part 22; Permissible for Underground Mines (Lithium-ion packs only)	–
UL	Class I, Division 1, Groups A, B, C, and D, Temperature Class T4 Class II, Groups F, and G Class I, Zone 0, AEx ia IIC, Temperature Class T4	-20 °C to +50 °C (-4 °F to +122 °F)

^aMarking requirements are reproduced in the *section below*.

^bMSHA requires the monitor be calibrated according to the procedures in the Product Manual only. MSHA also requires the monitor display methane in the percent-by-volume mode (0-5%) for compliance determinations required by 30 CFR Part 75, subpart D.

Marking Requirements

ATEX Markings

Industrial Scientific Corp.
15205 USA
VENTIS MX4
DEMKO 10 ATEX 1006410
Ex ia IIC T4 Ga
Ex ia I Ma
EN 60079-29-1
EN 50104
II 1G and I M1
-20°C ≤ Ta ≤ +50°C
IP 66/67

Aspirated Configuration

Use only replaceable battery pack P/N 17148313-1 or 17050608.

Do Not Recharge or Replace battery in Hazardous Locations.
Charging contact parameters: Um = 6.2V; li = 1.3A
[Serial Number] [Month/Year of Production]

Diffusion Configuration

Use only replaceable battery pack P/N 17148313-1, 17157350-XX, or 17134453-X1.

Do Not Recharge or Replace battery in Hazardous Locations.
Charging contact parameters: Um = 6.2V; li = 1.3A
[Serial Number] [Month/Year of Production]

IECEx Markings

Industrial Scientific Corp.
15205 USA
VENTIS MX4
IECEx UL10.0034
Ex ia IIC T4 Ga
-20°C ≤ Ta ≤ +50°C
IP 66/67

Aspirated Configuration

Use only replaceable battery pack P/N 17148313-1 or 17050608.

Do Not Recharge or Replace battery in Hazardous Locations.
Charging contact parameters: Um = 6.2V; li = 1.3A
[Serial Number] [Month/Year of Production]

Diffusion Configuration

Use only replaceable battery pack P/N 17148313-1, 17157350-XX, or 17134453-X1.

Do Not Recharge or Replace battery in Hazardous Locations.
Charging contact parameters: Um = 6.2V; li = 1.3A
[Serial Number] [Month/Year of Production]

Alkaline Battery Pack, P/N 17150608

Do Not Recharge or Replace battery in Hazardous Locations.
Only approved for use with three (3) AAA battery types
Duracell MN2400 and Energizer EN92. Replace all batteries
at the same time.

► Warranty

Industrial Scientific Corporation's Ventis MX4 portable gas monitors are warranted to be free from defects in material and workmanship under normal and proper use and service for a period of two years from date of purchase. This warranty includes the sensors, the pump, and the lithium-ion battery as shipped with the Ventis MX4.

Filters are warranted to be free from defects in material and workmanship for 18 months from date of shipment, or one year from date of first use, whichever occurs first, except where otherwise stated in writing in Industrial Scientific literature.

Limitation of Liability

THE WARRANTY SET FORTH ABOVE IS STRICTLY LIMITED TO ITS TERMS AND IS IN LIEU OF ALL OTHER WARRANTIES, GUARANTEES, EXPRESS OR IMPLIED, ARISING BY OPERATION OF LAW, COURSE OF DEALING, USAGE OF TRADE OR OTHERWISE. INDUSTRIAL SCIENTIFIC MAKES NO OTHER WARRANTIES, EITHER EXPRESSED OR IMPLIED, INCLUDING BUT NOT LIMITED TO THE WARRANTIES OF MERCHANTABILITY OR FITNESS FOR PARTICULAR PURPOSE.

SHOULD THE PRODUCT FAIL TO CONFORM TO THE ABOVE WARRANTY, BUYER'S ONLY REMEDY AND INDUSTRIAL SCIENTIFIC'S ONLY OBLIGATION SHALL BE, AT INDUSTRIAL SCIENTIFIC'S SOLE OPTION, REPLACEMENT OR REPAIR OF SUCH NON-CONFORMING GOODS OR REFUND OF THE ORIGINAL PURCHASE PRICE OF THE NON-CONFORMING GOODS.

IN NO EVENT WILL INDUSTRIAL SCIENTIFIC BE LIABLE FOR ANY OTHER SPECIAL, INCIDENTAL, OR CONSEQUENTIAL DAMAGES, INCLUDING LOSS OF PROFIT OR LOSS OF USE, ARISING OUT OF THE SALE, MANUFACTURE, OR USE OF ANY PRODUCTS SOLD HEREUNDER WHETHER SUCH CLAIM IS PLEADED IN CONTRACT OR IN TORT, INCLUDING STRICT LIABILITY IN TORT.

It shall be an express condition to Industrial Scientific's warranty that all products be carefully inspected for damage by Buyer upon receipt, be properly calibrated for Buyer's particular use, and be used, repaired, and maintained in strict accordance with the instructions set forth in Industrial Scientific's product literature. Repair or maintenance by non-qualified personnel will invalidate the warranty, as will the use of non-approved consumables or spare parts. As with any other sophisticated product, it is essential and a condition of Industrial Scientific's warranty that all personnel using the products be fully acquainted with their use, capabilities, and limitations as set forth in the applicable product literature.

Buyer acknowledges that it alone has determined the intended purpose and suitability of the goods purchased. It is expressly agreed by the parties that any technical or other advice given by Industrial Scientific with respect to the use of the goods or services is given without charge and at Buyer's risk; therefore, Industrial Scientific assumes no obligations or liability for the advice given or results obtained.

► Ventis MX4 Resource Center

Product documentation.
Online training.
And more!
www.indsci.com/ventis

Contact Information

Industrial Scientific Corporation

1 Life Way
Pittsburgh, PA 15205-7500
USA
Web: www.indsci.com
Phone: +1 412-788-4353 or 1-800-DETECTS (338-3287)
E-mail: info@indsci.com
Fax: +1 412-788-8353

Industrial Scientific France S.A.S.

5 Rue Frédéric Degeorge, CS 80097
62002 Arras Cedex,
France
Web: www.indsci.com
Phone: +33 (0)1 57 32 92 61
E-mail: info@eu.indsci.com
Fax: +33 (0)1 57 32 92 67

英思科传感仪器（上海）有限公司

地址：中国上海市浦东金桥出口加工区桂桥路290号
邮编：201206
电话：+86 21 5899 3279
传真：+86 21 5899 3280
E-mail： info@ap.indsci.com
网址： www.indsci.com
服务热线：+86 400 820 2515

To locate a nearby distributor of our products or an Industrial Scientific service center or business office, visit us at www.indsci.com.

Rendez-vous sur notre site Web www.indsci.com, si vous voulez trouver un distributeur de nos produits près de chez vous, ou, si vous recherchez un centre de service ou un bureau Industrial Scientific.

Besuchen Sie uns unter www.indsci.com, um einen Vertriebshändler unserer Produkte oder ein Servicecenter bzw. eine Niederlassung von Industrial Scientific zu finden.

Para buscar un distribuidor local de nuestros productos o un centro de servicio u oficina comercial de Industrial Scientific, visite www.indsci.com.

如需查找就近的产品经销商或 Industrial Scientific 服务中心或业务办事处，请访问我们的网站 www.indsci.com。

INDUSTRIAL SCIENTIFIC